



Desde 1973
**Equipamiento Profesional
para la Higiene y Colectividades**

Catálogo General 2025/26

Jami
HIGIENE, DISEÑO Y CALIDAD

www.jamibrisass.com

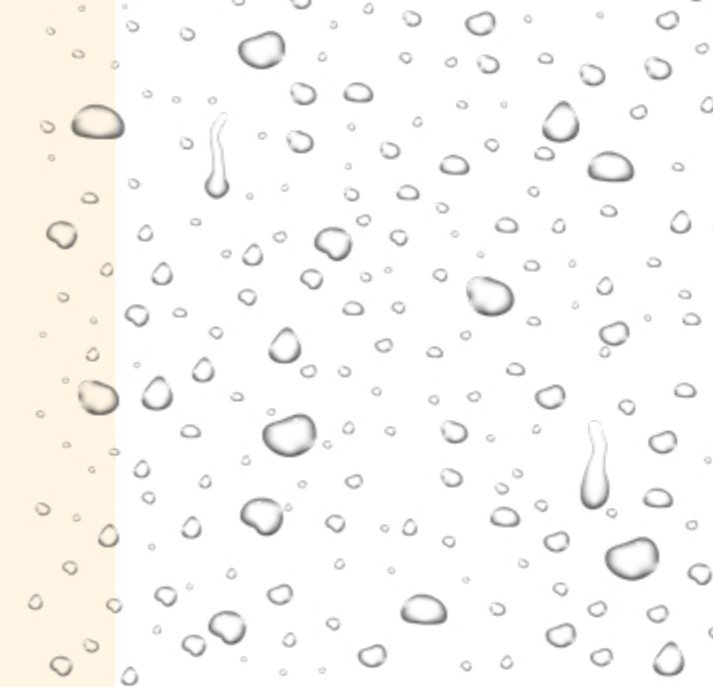

Jami Brisass® es una empresa fundada en el año 1973 y orientada siempre hacia el servicio y el cliente como centro de su negocio.

Nuestra empresa centra su actividad en la fabricación, diseño y comercialización de productos para el equipamiento profesional basado en la higiene y las colectividades, prestando especial atención a los artículos para baños y espacios adaptados en hostelería, residencias y resto de colectivos con áreas comunes.

Todo el equipo que formamos Jami Brisass® queremos aprovechar la edición de este nuevo catálogo para dar las gracias a todos aquellos clientes que siempre han confiado en nosotros y que siguen estando ahí. Y también a aquellos que oyen hablar de nosotros por primera vez.



“Presente a nivel nacional e internacional,
Jami Brisass® **fabrica y comercializa** sus
productos desde sus oficinas y almacenes
propios en **Málaga, Antequera y Sevilla**”

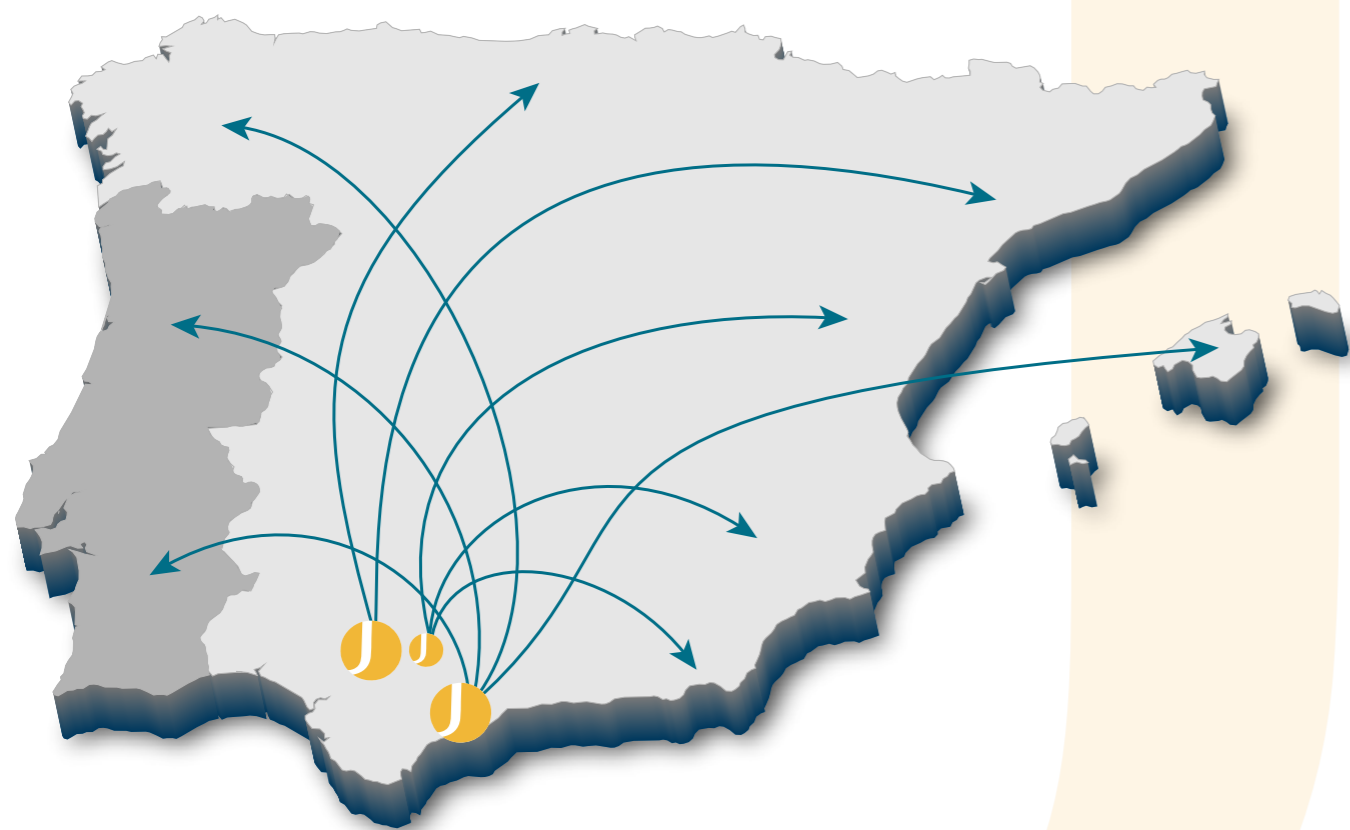

Presente en la arquitectura

Disponemos de fichas técnicas,
planos y medidas acotadas de cada
uno de nuestros productos.

Elementos BIM actualizados
Accesorios conformes a la normativa CTE
Asesoramiento técnico para prescripción

NUEVA WEB



Jami Brisass® presenta una nueva web, que va a permitir acceder a toda la información relativa a la empresa y sus productos de una forma muy fácil, rápida e intuitiva:

- Búsqueda e identificación fácil y cómoda de productos
- Descarga de documentación relevante
- Contacto directo e interactivo instantáneo para obtener asesoramiento

PRÓXIMAMENTE





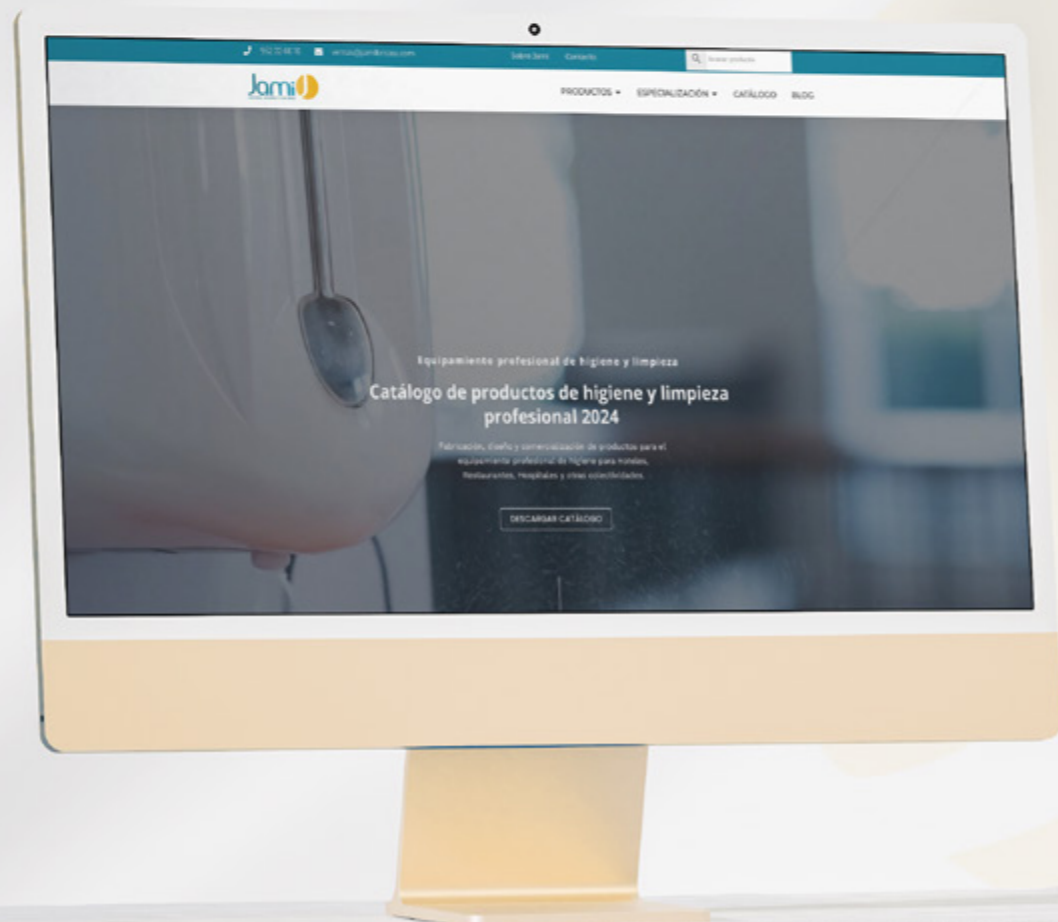

Nuevo Acceso privado para Clientes

Nueva funcionalidad para nuestros clientes para que, mediante un usuario y contraseña, puedan acceder de forma inmediata a un área privada para poder:

- Ver facturas e histórico de pedidos
- Hacer pedidos y ver el estado del envío al momento
- Solicitar reparaciones o incidencias
- Descargar documentación personalizada como tarifas y catálogos
- Y muchas cosas más...



ÍNDICE

-  Ahorro energético
-  Color personalizable
-  Secado rápido
-  Enchufe para afeitadora
-  Automático
-  Grifo de Agua
-  Corriente Alterna

Secadores de Manos	09
ABS	10
Acero y Aluminio	11
Diseño Premium	14
Jet	15
Secadores de Cabello	19
Dosificadores de Jabón	25
ABS	26
Acero	30
Dispensadores de Papel	35
Higiénico Industrial y Doméstico	36
Toalla y Mecha	40
Bobina y Equipos Compactos	42
LÍNEA COMPLETA VELETA	44
LÍNEA COMPLETA DONOSTI	46
Accesorios de Baño	49
Línea Granito	50
Línea Titania	52
Línea Zafiro	54
Línea Andalucita	56
Línea Ópalo	58
Línea Siderita	62
Espejos y Dispensadores	64
Toalleros Eléctricos y de Agua	65
Saneamientos Acero Inoxidable	66
Baños Adaptados	69
Barras Abatibles	70
Barras Rectas y de Ángulo	72
Asientos de Ducha	76
Saneamientos Adaptados	78
Mesas Cambiabebés	82
Fuentes de Agua	85
Papeleras y Ceniceros	89
Papeleras de Baño, Compreseros	90
Papeleras de Pedal y Basculantes	92
Papeleras de Interior y Oficina	96
Papeleras de Clasificación	100
Papeleras de Exterior	104
Papeleras de Parking	106
Ceniceros	107
Contenedores	109
Dispensadores de Aerosoles. Exterminadores	113
Taquillas y Bancos de Vestuario	117
Carros de Limpieza y Servicio	121
Carros de Limpieza	122
Carros de Servicio	124
Complementos Hotel	127
Duchas Lavaojos	134



Ver
productos



Secadores de Manos

El secador de manos se ha convertido en una solución imprescindible para cualquier negocio a la hora de secarse las manos debido a las numerosas ventajas que aporta a la higiene.

Una de las más importantes es la capacidad que tiene de disminuir la cantidad de gérmenes y bacterias que se adhieren a las manos.





Calcita

Secamanos automático en ABS Blanco.

- ▶ Diseño compacto y elegante
- ▶ Función apagado automático de seguridad a los 60 seg.
- ▶ Potencia 1.650W.



Referencia	Color	U. / Caja
SM836ABW0	Blanco	8
SM836ABN0	Negro	8

225 mm

284 mm

161 mm



Automático



Jaspe

Secamanos automático en ABS Blanco.

- ▶ Tapa plástica ABS compacta y resistente.
- ▶ Excelente relación calidad/precio.
- ▶ Potencia 1.000W



Referencia	Color	U. / Caja
SM824ABW0	Blanco	6

210 mm

285 mm

145 mm



Automático



Rubí

Secamanos automático en ABS Blanco.

- ▶ Secado rápido por cortina de aire.
- ▶ Sistema integrado de ahorro energético que se activa cuando la temperatura ambiente supera los 25°C, ya que al detectarse desactiva la resistencia y opera únicamente con el motor.
- ▶ Potencia 1.400W.



Referencia	Color	U. / Caja
SM811ABW0	Blanco	4

250 mm

235 mm

165 mm



Secado rápido
Automático
Ahorro energético



Calcita

Secamanos automático en acero inoxidable Aisi 304

- ▶ Diseño compacto y elegante
- ▶ Función apagado automático de seguridad a los 60 seg.
- ▶ Potencia 1.650W.



Satinado



Brillo

Referencia	Color	U. / Caja
SM833AIS0	Satinado	8
SM834AIB0	Brillo	8
SM839AIN0	Negro	8

225 mm

284 mm

161 mm

NUEVO



Negro



Automático



Ágata

Secamanos con pulsador en acero inoxidable.

- ▶ Carcasa antivandática muy robusta.
- ▶ Larga duración y a prueba de golpes.
- ▶ Potencia 2.500W.

Referencia	Color	U. / Caja
SM800AIS0	Satinado	4
SM800AIB0	Brillo	4
SM802ACW0	Blanco	4

- 270 mm
- 240 mm
- 200 mm



Barita

Secamanos automático en acero inoxidable.

- ▶ Carcasa antivandática muy robusta.
- ▶ Larga duración y a prueba de golpes.
- ▶ Potencia 2.500W.

Referencia	Color	U. / Caja
SM801AIS0	Satinado	4
SM805AIB0	Brillo	4
SM805ACW0	Blanco	4
SM801AIN0	Negro NUEVO	4

- 270 mm
- 240 mm
- 200 mm



Plata

Secamanos automático en aluminio.

- ▶ Carcasa antivandática.
- ▶ Diseño atractivo con dimensiones reducidas.
- ▶ Potencia 1.600W.

Referencia	Color	U. / Caja
SM828ALS0	Satinado	4
SM828ALW0	Blanco	4

- 268 mm
- 206 mm
- 150 mm



Automático



Dolomita

Secamanos automático en acero inoxidable Satinado. Adaptado para personas con movilidad reducida.(PMR). Normativa ADA.

- ▶ Tiene la capacidad de funcionar a sólo 400W, apagándose la resistencia interna con el consiguiente ahorro energético.
- ▶ Cumple con la normativa ADA.
- ▶ Potencia 950W.

Referencia	Color	U. / Caja
SM841AIS0	Satinado	4

- 275 mm
- 300 mm
- 100 mm



Normativa ADA



Ámbar

Secamanos ultrarápido en acero inoxidable Aisi 304

- ▶ Sistema integrado de ahorro energético que se activa cuando la temperatura ambiente supera los 25°C, ya que al detectarse desactiva la resistencia y opera únicamente con el motor.
- ▶ Incluye filtro HEPA H13 para la purificación del aire.
- ▶ Potencia 1.200W.

Referencia	Color	U. / Caja
SM810AIS0	Satinado	4
SM810AIB0	Brillo	4
SM810AIN0	Negro	4

- 302 mm
- 312 mm
- 172 mm



Satinado

Brillo



Negro



Secado rápido | Automático | Ahorro energético



Turmalina

Secamanos automático en latón cromado con una salida de aire.

- ▶ Diseño innovador y atractivo.
- ▶ Larga vida útil del motor de hasta 7-10 años.
- ▶ Profundidad mínima del lavabo: 100 mm.
- ▶ Incluye filtro HEPA H13 para la purificación del aire.
- ▶ Potencia 500W.



Secado rápido
Automático
Ahorro energético

Referencia	Color	U. / Caja
SM601LTC1	Cromado	2

- 40 mm
- 170 mm
- 221 mm



Pirita

Secamanos Jet en ABS.

- ▶ Bandeja de recogida de agua sobrante.
- ▶ Ahorro en mantenimiento.
- ▶ Incluye filtro HEPA H13 para la purificación del aire.
- ▶ Potencia 1.650W.



blanco



Plata



Secado rápido | Automático | Ahorro energético

Referencia	Color	U. / Caja
SM835ABWO	Blanco	2
SM837ABGO	Gris Plata	2

- 300 mm
- 684 mm
- 220 mm



Bismuto

Secamanos automático en latón cromado con grifo y dos salidas de aire.

- ▶ Incorpora grifo + secador automático con dos salidas de aire 2 en 1.
- ▶ Larga vida útil del motor de hasta 7-10 años.
- ▶ Profundidad mínima del lavabo: 100 mm.
- ▶ Incluye filtro HEPA H13 para la purificación del aire.
- ▶ Potencia 800W.



Grifo de Agua
Automático

Referencia	Color	U. / Caja
SM602LTC1	Cromado	2

- 260 mm
- 141 mm
- 175 mm



NUEVO

Challenger

Secamanos ultrarapido ABS

- ▶ Diseño compacto atractivo
- ▶ Secado rápido por cortina de aire
- ▶ Alto caudal de salida
- ▶ Potencia 1.300 W

Referencia	Color	U. / Caja
SM842ABGO	Gris Metalizado	1

- 234mm
- 384mm
- 142mm

	ABS				Acero y Aluminio		
	SM836ABWO Mod. Calcita	SM836ABNO Mod. Calcita	SM824ABWO Mod. Jaspe	SM811ABWO Mod. Rubí	SM833AIS0 Mod. Calcita	SM834AIB0 Mod. Calcita	SM839AIN0 Mod. Calcita
Funcionamiento	Sensor eléctrico	Sensor eléctrico	Sensor eléctrico	Sensor eléctrico	Sensor eléctrico	Sensor eléctrico	Sensor eléctrico
Voltaje	220 V	220 V	220 V	220 V	220 V	220 V	220 V
Frecuencia	50 Hz	50 Hz	50 Hz	50 Hz	50 Hz	50 Hz	50 Hz
Potencia	1650 W	1650 W	1000 W	1650 W	1650 W	1650 W	1650 W
Consumo eléctrico	7,5 A	7,5 A	4,5 A	6.36 A	7,5 A	7,5 A	7,5 A
Índice de protección	IPX1	IPX1	IPX1	IPX1	IPX1	IPX1	IPX1
Paro automático	60 seg	60 seg	60 seg	45 seg	60 seg	60 seg	60 seg
Tipo Motor	Universal	Universal	Universal	Universal	Universal	Universal	Universal
Sensibilidad al sensor	9-15 cm	9-15 cm	0-11 cm	0-15 cm	9-15 cm	9-15 cm	9-15 cm
Material	ABS	ABS	ABS	ABS	Acero inoxidable	Acero inoxidable	Acero inoxidable
Acabado	Blanco	Blanco	Blanco	Blanco	Satinado	Brillo	Negro
Medidas mm	285x225x165	285x225x165	285x210x145	235x250x165	285x225x165	285x225x165	285x225x165
Peso	3,100 Kg	3,100 Kg	1,600 Kg	3,700 Kg	3,100 Kg	3,100 Kg	3,100 Kg
Caudal eficaz	95 m3/h	95 m3/h	66 m3/h	100.8 m3/h	95 m3/h	95 m3/h	95 m3/h
Velocidad del aire	17 m/s	17 m/s	13 m/s	105 m/s	17 m/s	17 m/s	17 m/s
Tiempo de secado	40-50 seg	40-50 seg	50 seg	10-15 seg	40-50 seg	40-50 seg	40-50 seg

	Acero y Aluminio						
	SM800AIB0 Mod. Ágata	SM800AIS0 Mod. Ágata	SM802ACW0 Mod. Ágata	SM801AIS0 Mod. Barita	SM805AIB0 Mod. Barita	SM805ACW0 Mod. Barita	SM801AIN0 Mod. Barita
Funcionamiento	Pulsador	Pulsador	Pulsador	Sensor eléctrico	Sensor eléctrico	Sensor eléctrico	Sensor eléctrico
Voltaje	220 V	220 V	220 V	220 V	220 V	220 V	220 V
Frecuencia	50 Hz	50 Hz	50 Hz	50 Hz	50 Hz	50 Hz	50 Hz
Potencia	2500 W	2500 W	2500 W	2500 W	2500 W	2500 W	2500 W
Consumo eléctrico	11,4 A	11,4 A	11,4 A	11,4 A	11,4 A	11,4 A	11,4 A
Índice de protección	IPX1	IPX1	IPX1	IPX1	IPX1	IPX1	IPX1
Paro automático	35 seg	35 seg	35 seg	60 seg	60 seg	60 seg	60 seg
Tipo Motor	Universal	Universal	Universal	Universal	Universal	Universal	Universal
Sensibilidad al sensor	-	-	-	0-11 cm	0-11 cm	0-11 cm	0-11 cm
Material	Acero inoxidable	Acero	Acero	Acero	Acero inoxidable	Acero	Acero
Acabado	Brillo	Satinado	Epoxi blanco	Satinado	Brillo	Epoxi blanco	Negro
Medidas mm	240x270x200	240x270x200	240x270x200	240x270x200	240x270x200	240x270x200	240x270x200
Peso	5,800 Kg	5,800 Kg	5,800 Kg	6,000 Kg	6,000 Kg	6,000 Kg	6,000 Kg
Caudal eficaz	270 m3/h	270 m3/h	270 m3/h	270 m3/h	270 m3/h	270 m3/h	270 m3/h
Velocidad del aire	30 m/s	30 m/s	30 m/s	30 m/s	30 m/s	30 m/s	30 m/s
Tiempo de secado	10-15 seg	10-15 seg	10-15 seg	10-15 seg	10-15 seg	10-15 seg	10-15 seg

	Acero y Aluminio					
	SM828ALS0 Mod. Plata	SM828ALW0 Mod. Plata	SM841AIS0 Mod. Dolomita	SM810AIS0 Mod. Ámbar	SM810AIB0 Mod. Ámbar	SM810AIN0 Mod. Ámbar
Funcionamiento	Sensor eléctrico	Sensor eléctrico	Sensor eléctrico	Sensor eléctrico	Sensor eléctrico	Sensor eléctrico
Voltaje	220 V	220 V	220 V	220 V	220 V	220 V
Frecuencia	50 Hz	50 Hz	50 Hz	50 Hz	50 Hz	50 Hz
Potencia	1600 W	1600 W	400-950 W	1400 W	1400 W	1400 W
Consumo eléctrico	7,3 A	7,3 A	4.2 A	6.36 A	6.36 A	6.36 A
Índice de protección	IPX1	IPX1	IPX3	IPX1	IPX1	IPX1
Paro automático	60 seg	60 seg	60 seg	45 seg	45 seg	45 seg
Tipo Motor	Universal	Universal	Universal	Universal	Universal	Universal
Sensibilidad al sensor	0-11cm	0-11 cm		0-15 cm	0-15 cm	0-15 cm
Material	Aluminio	Aluminio	Acero inoxidable	Acero inoxidable	Acero inoxidable	Acero inoxidable
Acabado	Satinado	Blanco	Satinado	Satinado	Brillo	Negro
Medidas mm	206x268x150	206x268x150	300x272x100	312x302x172	312x302x172	312x302x172
Peso	3,500 Kg	3,500 Kg	4,500 kg	4,100 Kg	4,100 Kg	4,100 Kg
Caudal eficaz	181 m3/h	181 m3/h	-	122.4 m3/h	122.4 m3/h	122.4 m3/h
Velocidad del aire	12 m/s	12 m/s	95 m/s	70 m/s	70 m/s	70 m/s
Tiempo de secado	40-50 seg	40-50 seg	10-15 seg	10-15 seg	10-15 seg	10-15 seg

	Jet			Diseño Premium	
	SM835ABW0 Mod. Pirita	SM837ABG0 Mod. Pirita	SM842ABG0 Mod. Challenger	SM601LTC0 Mod. Turmalina	SM602LTC0 Mod. Bismuto
Funcionamiento	Sensor eléctrico	Sensor eléctrico	Seensor electrico	Sensor eléctrico	Sensor eléctrico
Voltaje	220 V	220 V	220 V	220 V	220 V
Frecuencia	50 Hz	50 Hz	50/60Hz	50 Hz	50 Hz
Potencia	1650 W	1650 W	1300 W	500 W	800 W
Consumo eléctrico	7.5 A	7.5 A	5.9 A	3.1 A	3.5 A
Índice de protección	IPX4	IPX4	IPX1	IP24	IP24
Paro automático	30 seg	30 seg	-	30 seg	30 seg
Tipo Motor	Sin escobillas	Sin escobillas	Universal	Sin escobillas	Sin escobillas
Sensibilidad al sensor	-	-	-	5-12 cm	5-12 cm
Material	ABS	ABS	ABS	Latón	Latón
Acabado	Blanco	Gris/plata	GRIS METALIZADO	Satinado	Cromado
Medidas mm	684x300x220	684x300x220	234x384x142	170x40x221	141x260x175
Peso	11,000 Kg	11,000 Kg	-	4,400 kg	5,800 Kg
Caudal eficaz	200 m3/h	200 m3/h	-	-	-
Velocidad del aire	80-95 m/s	80-95 m/s	150 m/s	90 m/s	95 m/s
Tiempo de secado	5-7 seg	5-7 seg	7-9 seg	10-15 seg	10-15 seg



Ver
productos



Secadores de Cabello

Los secadores de cabello son una herramienta fundamental para el cuidado del cabello. Se utilizan para secar, peinar y dar forma al cabello. Para que un secador de pelo sea eficaz, es imprescindible que tenga una potencia adecuada y que caliente bien. La potencia es la capacidad del secador para generar aire y calor.

Jami
HIGIENE, DISEÑO Y CALIDAD



Galena

Secador de cabello tipo pistola en ABS.

- ▶ Dos velocidades.
- ▶ Diseño compacto.
- ▶ Potencia 600/1.200W.

Referencia	Color	U. / Caja
SP884ABW0	Blanco	12
SP864ABN0	Negro	12

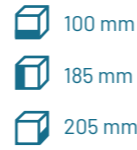

Albita

Secador de cabello tipo pistola en ABS.

- ▶ Dos velocidades.
- ▶ Apto para colectividades.
- ▶ Potencia 600/1.200W.

Referencia	Color	U. / Caja
SP880ABW0	Blanco	12
SP880ABN0	Negro	12



Berilo

Secador de cabello tipo teléfono en ABS.

- ▶ Apto para uso intensivo.
- ▶ Apto para colectividades.
- ▶ Potencia 1.500W.

Referencia	Color	U. / Caja
SP873ABW0	Blanco	6

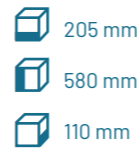

Minio

Secador de cabello tipo pistola con enchufe para afeitadora en ABS.

- ▶ Dos velocidades.
- ▶ Con enchufe para afeitadora.
- ▶ Potencia 600/1.200W.

Referencia	Color	U. / Caja
SP868ABW0	Blanco	12

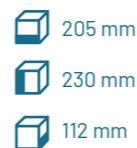

Enchufe para afeitadora



Soporte Físico

Soporte Magnético

ION OXIRON

Secador de cabello inteligente de diseño compacto

- ▶ Secador de pelo compacto de diseño inteligente.
- ▶ Diseño ergonómico para un uso cómodo.
- ▶ Disponible con soporte magnético o físico.
- ▶ Con pantalla LED.
- ▶ Potencia 1.600W.



Referencia	Color	U. / Caja
SP894AC00	Gris	30

Soporte Físico

SP897PON1	Negro
-----------	-------

Soporte Magnético

SP896PON1	Negro
-----------	-------



Perlita

Secador de cabello tipo pistola 1800W

- ▶ Disponible con funda de guardado.
- ▶ Dos velocidades.
- ▶ Apto para uso intensivo.
- ▶ Potencia 1.800W.

Referencia	Color	U. / Caja
SP893ABN1	Negro / Plata	12



bolsa de guardado

AH007LON0	Negro	12
-----------	-------	----





Enchufe para afeitadora

Diamante

Secador de cabello tipo pistola con enchufe para afeitadora en ABS.

- ▶ Dos velocidades.
- ▶ Con enchufe para afeitadora.
- ▶ Potencia 600/1.200W.



Referencia	Color	U. / Caja
SP885ABW1	Blanco	12

- 180 mm
- 210 mm
- 91 mm



Corriente Alterna

Fluorita

Secador de cabello tipo pistola en Acero y ABS.

- ▶ Alto rendimiento.
- ▶ Alta presión de aire.
- ▶ Motor con una mayor vida útil.
- ▶ Potencia 1.800W.



Referencia	Color	U. / Caja
SP700ABNO	Acero y Negro	12

- 135 mm
- 270 mm
- 220 mm



Axinita

Secador de cabello tipo pistola en ABS.

- ▶ Dos velocidades.
- ▶ Apto para uso intensivo.
- ▶ Potencia 1.800W.



Referencia	Color	U. / Caja
SP887ABW0	Blanco	12
SP887ABNO	Negro	12

- 225 mm
- 185 mm
- 145 mm



Enchufe para afeitadora

Azurita

Secador de cabello tipo pistola con enchufe para afeitadora

- ▶ Alta potencia.
- ▶ Dos velocidades.
- ▶ Apto para uso intensivo.
- ▶ Con enchufe para afeitadora.
- ▶ Potencia 1.800W.



Referencia	Color	U. / Caja
SP886ABW0	Blanco	12

- 255 mm
- 250 mm
- 145 mm

	SP864ABNO Mod. Galena	SP884ABW0 Mod. Galena	SP880ABNO Mod. Albita	SP880ABW0 Mod. Albita	SP873ABW0 Mod. Berilo	SP868ABW0 Mod. Minio	SP893ABN1 Mod. Perlita
Funcionamiento	Interruptor Pulsador	Interruptor Pulsador	Interruptor Pulsador	Interruptor Pulsador	Automático	Interruptor Pulsador	Interruptor pulsador
Voltaje	220 V	220 V	220 V	220 V	220 V	220 V	220v-240v
Frecuencia	50 Hz	50 Hz	50 Hz	50 Hz	50 Hz	50 Hz	50hz
Potencia	600 / 1200 W	600 / 1200 W	600 / 1200 W	600 / 1200 W	1500 W	600 / 1200 W	1800w
Consumo eléctrico	5.45 A	5.45 A	5.45 A	5.45 A	6.5 A	5.5 A	3.68-7.5 A
Tipo Motor	Universal	Universal	Universal	Universal	Universal	Universal	Universal
Material	ABS	ABS	ABS	ABS	ABS	ABS	Abs
Acabado	Negro	Blanco	Negro	Blanco	Blanco	Blanco	Negro/plata
Medidas mm	185x100x205	185x100x205	210x181x90	210x181x90	580x205x110	230x205x112	180/253/78
Peso	0,700 Kg	0,700 Kg	0,850 Kg	0,850 Kg	2,100 Kg	1,300 Kg	1,160 Kg
Caudal eficaz	78 m3/h	78 m3/h	73 m3/h	73 m3/h	87 m3/h	78 m3/h	80 M3/h
Velocidad del aire	14 m/s	14 m/s	20 m/s	20 m/s	17 m/s	14 m/s	25m/s

	SP894ACO Mod. Ion Oxiron	SP885ABW0 Mod. Diamante	SP700ABNO Mod. Fluorita	SP887ABNO Mod. Axinita	SP887ABW0 Mod. Axinita	SP886ABW0 Mod. Azurita
Funcionamiento	Interruptor pulsador	Interruptor Pulsador	Interruptor Pulsador	Interruptor Pulsador	Interruptor Pulsador	Interruptor Pulsador
Voltaje	220V	220 V	220 V	220 V	220 V	220 V
Frecuencia	50Hz	50 Hz	50 Hz	50 Hz	50 Hz	50 Hz
Potencia	1600W	600 / 1200 W	1800 W	1800 W	1800 W	1800 W
Consumo eléctrico	7,5 A	5.5 A	8.18 A	8.1 A	8.1 A	8.1 A
Tipo Motor	Brushless	Universal	Corriente Alterna	Universal	Universal	Universal
Material	Policarbonato/ Nylon	ABS	ABS/Acero	ABS	ABS	ABS
Acabado	Gris Oscuro	Blanco	Negro/Plata	Negro	Blanco	Blanco
Medidas mm	270x71x90	210x180x91	270x135x220	185x225x145	185x225x145	250x225x145
Peso	560 g	1,300 Kg	1.166 kg	1,100 Kg	1,100 Kg	1,450 Kg
Caudal eficaz	136 m3/h	78 m3/h	75 m3/h	80 m3/h	80 m3/h	80 m3/h
Velocidad del aire	22m/s	14 m/s	22 m/s	25 m/s	25 m/s	25 m/s



Ver
productos



Dosificadores de Jabón

Lavarnos las manos correcta y frecuentemente es fundamental si queremos eliminar todo tipo de gérmenes. Disponer de un dispensador de jabón en nuestro negocio es un factor esencial a la hora de ofrecer un correcto servicio de higiene tanto a nuestros trabajadores como a nuestros clientes. Los dosificadores de jabón son una herramienta indispensable para mantener una buena higiene, ya que permiten dispensar jabón de forma controlada y uniforme.



Orión

Dosificador de jabón con pulsador en ABS de 400ml.

- ▶ Abs resistente.
- ▶ Apto para colectividades.
- ▶ Visor de nivel.
- ▶ Fácil llenado desde la parte superior.



- 80 mm
- 195 mm
- 86 mm

Referencia	Capacidad	Color	U. / Caja
DJ134ABW0	400ml	Blanco	30
DJ135ABG0	400ml	Gris	30

Orión Doble

Dosificador de jabón doble con pulsador en ABS de 2x400ml.

- ▶ Abs resistente.
- ▶ Apto para colectividades.
- ▶ Visor de nivel.
- ▶ Fácil llenado desde la parte superior.
- ▶ Ideal para lugares donde se necesiten combinar 2 o más tipos de productos de baño.

Referencia	Capacidad	Color	U. / Caja
DJ136ABW0	2x400ml	Blanco	16
DJ137ABG0	2x400ml	Gris	16

- 181 mm
- 193 mm
- 93 mm



Veleta

Dosificador de jabón o espuma con pulsador en ABS de 1L.

- ▶ Depósito rígido interior.
- ▶ Visor de nivel.
- ▶ Apropiado para colectividades.



Blanco

Referencia	Capacidad	Color	U. / Caja
DJ212ABW0 - Gel	1L	Blanco	48
DJ210ABW0 - Espuma	1L	Blanco	48
DJ212ABN0 - Gel	1L	Negro	48
DJ210ABN0 - Espuma	1L	Negro	48

- 138 mm
- 205 mm
- 132 mm



Donosti

Dosificador de jabón o espuma con pulsador en ABS de 1L.

- ▶ Depósito rígido interior.
- ▶ Visor de nivel.
- ▶ Apropiado para colectividades.



Blanco

Referencia	Capacidad	Color	U. / Caja
DJ180ABW0 - Gel Blanco	1L	Blanco	48
DJ181ABW0 - Espuma Blanco	1L	Blanco	48
DJ180ABN0 - Gel Negro	1L	Negro	48
DJ181ABN0 - Espuma Negro	1L	Negro	48

- 138,08 mm
- 204,99 mm
- 128,28 mm



Atlántico

Dosificador de jabón con pulsador en ABS de 0,9L.

- ▶ Abs resistente.
- ▶ Visor de nivel.
- ▶ Depósito interior.



Referencia	Capacidad	Color	U. / Caja
DJ700ABW0	700ml	Blanco	10
DJ700ABN0	700ml	Negro	10

- 128 mm
- 210mm
- 90 mm



Vithas

Dosificador de jabón con pulsador palanca de acero en ABS de 1L.

- ▶ Abs resistente.
- ▶ Fácil llenado desde la parte superior.
- ▶ Accionamiento con el codo. Ideal para hospitales, quirófanos y cocinas industriales. Cumple normativa.



- 120 mm
- 220 mm
- 135 mm

Referencia	Capacidad	Color	U. / Caja
DJ155ABW0	1L	Blanco	18



Grass

Dosificador de jabón con pulsador en ABS de 3L.

- ▶ Fabricado en polietileno, lo que le confiere una gran resistencia a la fatiga mecánica.
- ▶ Admite jabón líquido, cremoso y pasta.
- ▶ Fácil llenado desde la parte superior.
- ▶ Ideal para fábricas y talleres.



- 132 mm
- 333 mm
- 145 mm

Referencia	Capacidad	Color	U. / Caja
DJ156ABW1	3L	Blanco y Azul	20



Terra

Dosificador de jabón encastrable con botella de polietileno de 1L.

- ▶ Depósito interior de polietileno de gran capacidad.
- ▶ Fácil llenado desde la parte superior.
- ▶ Dosificador encastrable con depósito oculto bajo la superficie.



- 87 mm
- 330 mm
- 180 mm

Referencia	Capacidad	Color	U. / Caja
DJ973AIB1	1L	Inoxidable Brillo	28



Fumé

Dosificador de jabón con pulsador en ABS de 1L.

- ▶ Abs resistente.
- ▶ Apto para colectividades.
- ▶ Recipiente traslúcido para ver el nivel.
- ▶ Fácil llenado desde la parte superior.

- 130 mm
- 170 mm

Referencia	Capacidad	Color	U. / Caja
DJ105ABF0	1L	Translúcido	18



Electra

Dosificador de jabón automático en ABS de 1L. Compatible con corriente eléctrica. A pilas 1,5v (no se incluyen).

- ▶ Compatible con corriente eléctrica. (no incluye adaptador)
- ▶ Depósito interior.
- ▶ Apto para uso intensivo en colectividades.
- ▶ Visor de llenado.

- 125 mm
- 260 mm
- 105 mm

Referencia	Capacidad	Color	U. / Caja
DJ160ABW0	1L	Blanco	24



Goiko

Dosificador de jabón automático en ABS de 1,1L. A pilas 1,5v (no se incluyen).

- ▶ Abs resistente.
- ▶ Visor de nivel.
- ▶ Depósito interior.
- ▶ Caudal limitado a 1 ml cada 3 segundos.

- 140 mm
- 235 mm
- 107 mm

Referencia	Capacidad	Color	U. / Caja
DJ133ABW0	1,1L	Blanco	12

Sofia VE

Dosificador de jabón vertical con pulsador en acero inoxidable. Aisi 304 en 0,5L y 1L.

- ▶ Acero AISI 304 resistente a la corrosión y antivandálico.
- ▶ Visor de nivel.
- ▶ Fácil rellenado por la parte superior.



Referencia	Capacidad	Color	U. / Caja
DJ102AISO	0,5L	Satinado	24
DJ101AIBO	0,5L	Brillo	24

Referencia	Capacidad	Color	U. / Caja
DJ104AISO	1L	Satinado	24
DJ132AIBO	1L	Brillo	24
DJ104AIN1	1L	Negro NUEVO	24

- 98 mm
- 153 mm
- 63/115 mm
- 122 mm
- 202 mm
- 62/115 mm



Sofia H0

Dosificador de jabón horizontal con pulsador en acero inoxidable. Aisi 304 en 1L.

- ▶ Acero AISI 304 resistente a la corrosión y antivandálico.
- ▶ Visor de nivel.
- ▶ Fácil rellenado por la parte superior.

Referencia	Capacidad	Color	U. / Caja
DJ103AISO	1L	Satinado	24
DJ131AIBO	1L	Brillo	24

- 202 mm
- 122 mm
- 62/115 mm



Venus VE

Dosificador de jabón vertical con pulsador en acero inoxidable. Aisi 304 en 1,2L. Depósito interior de plástico.

- ▶ Acero AISI 304 resistente a la corrosión y antivandálico.
- ▶ Visor de nivel.
- ▶ Fácil rellenado por la parte superior.



Referencia	Capacidad	Color	U. / Caja
DJ120AISO	1,2L	Satinado	24
DJ120AIBO	1,2L	Brillo	24

- 122 mm
- 202 mm
- 72/124 mm



Venus H0

Dosificador de jabón horizontal con pulsador en acero inoxidable. Aisi 304 en 1,2L. Depósito interior de plástico.

- ▶ Acero AISI 304 resistente a la corrosión y antivandálico.
- ▶ Visor de nivel.
- ▶ Fácil rellenado por la parte superior.

Referencia	Capacidad	Color	U. / Caja
DJ121AISO	1,2L	Satinado	24
DJ121AIBO	1,2L	Brillo	24

- 202 mm
- 122 mm
- 72/124 mm



Airbus

Dosificador de jabón con pulsador en acero inoxidable. Aisi 304 en 1,8L.

- ▶ Acero AISI 304 resistente a la corrosión y antivandálico.
- ▶ Visor de nivel.
- ▶ Válvula antigoteo.
- ▶ Sistema de bloqueo antirrobo.
- ▶ Fácil rellenado por la parte superior.
- ▶ Apto para uso intensivo en colectividades.

Referencia	Capacidad	Color	U. / Caja
DJ146AISO	1,8L	Satinado	16
DJ150AIBO	1,8L	Brillo	16

- 140 mm
- 210 mm
- 120 mm



Satinado



Brillo



Bolio

Dosificador de jabón horizontal encastrable con pulsador en acero inoxidable. en 1L.

- ▶ Acero AISI 304 resistente a la corrosión y antivandálico.
- ▶ Visor de nivel.
- ▶ Depósito interior que evita aún más la corrosión.
- ▶ Apto para uso intensivo en colectividades.

Referencia	Capacidad	Color	U. / Caja
DJ300AIS0	1L	Satinado	12
DJ300AIB0	1L	Brillo	12

240 mm

140 mm

98/150 mm



Apolo

Dosificador de jabón con pulsador en acero inoxidable en 0,3L. Depósito interior de plástico.

- ▶ Acero AISI 304 resistente a la corrosión y antivandálico.
- ▶ Depósito interior que evita aún más la corrosión.
- ▶ Apto para uso intensivo en colectividades.

NUEVO

Referencia	Capacidad	Color	U. / Caja
DJ109AIS1	0,3L	Satinado	12

62 mm

245 mm

90 mm



Valera

Dosificador automático en acero inoxidable. Aisi 304 en 0,7L. Ofrece 5 posiciones de dosificación.

- ▶ Acero AISI 304 resistente a la corrosión y antivandálico.
- ▶ Depósito interior que evita aún más la corrosión.
- ▶ Apto para uso intensivo en colectividades.
- ▶ Dosificación automática sin contacto.
- ▶ 5 posiciones de dosificación.

Referencia	Capacidad	Color	U. / Caja
DJ159AIS0	0,7L	Satinado	12
DJ159AIN1	0,7L	Negro	12

255 mm

250 mm

145 mm



Leo

Dosificador automático en acero inoxidable. Aisi 304 en 1,2L.

- ▶ Acero AISI 304 resistente a la corrosión y antivandálico.
- ▶ Visor de nivel.
- ▶ Válvula antigoteo.
- ▶ Sistema de bloqueo antirrobo.
- ▶ Apto para uso intensivo en colectividades.
- ▶ Dosificación automática sin contacto

Referencia	Capacidad	Color	U. / Caja
DJ154AIS0	1,2L	Satinado	16
DJ153AIB0	1,2L	Brillo	16

RECOMENDADO POR EL CLIENTE

205 mm

230 mm

112 mm



Dispensadores de Papel

El dispensador de papel no solo promueve un método de secado de manos más seguro y cómodo, sino que también es capaz de evitar que las áreas de trabajo se conviertan en ambientes propulsores de enfermedades.

El dispensador de papel higiénico industrial es fundamental para evitar el desperdicio y ayudar a mantener los baños limpios y ordenados.



Ver
productos





Luna

Dispensador de papel higiénico industrial en acero inoxidable.

- ▶ Fabricado en acero resistente a la corrosión.
- ▶ Visor de nivel de carga.
- ▶ Cerradura con llave.
- ▶ Antivandálico.

Referencia	Color	U. / Caja
DP116AIS0	Satinado	6
DP117AIB0	Brillo	6
DP118ACW0	Blanco	6
DP116AIN0	Negro NUEVO	6



Veleta Mixto

Dispensador de papel higiénico mixto en ABS. Admite rollo domestico hoja a hoja.

- ▶ Diseño único y atractivo.
- ▶ Visor de nivel de carga.
- ▶ Apropiado para colectividades.

Referencia	Color	U. / Caja
DP213ABW0	Blanco	48



Veleta

Dispensador de papel higiénico industrial en ABS.

- ▶ Diseño único y atractivo.
- ▶ Visor de nivel de carga.
- ▶ Apropiado para colectividades.

Referencia	Color	U. / Caja
DP210ABW0	Blanco	24
DP210ABN0	Negro	24



Donosti

Dispensador de papel higiénico industrial en ABS.

- ▶ Diseño único y atractivo.
- ▶ Visor de nivel de carga.
- ▶ Apropiado para colectividades.

Referencia	Color	U. / Caja
DP180ABW0	Blanco	1
DP180ABN0	Negro	1



Luxury

Dispensador de papel higiénico industrial en acero inoxidable Aisi 304. Fabricado por embutición.

- ▶ Fabricado en acero resistente a la corrosión.
- ▶ Visor de nivel de carga.
- ▶ Apropiado para colectividades.
- ▶ Antivandálico.
- ▶ Fabricado por embutición.

Referencia	Color	U. / Caja	280 mm
DP143AIS0	Satinado	4	280 mm
DP144AIB0	Brillo	4	130 mm

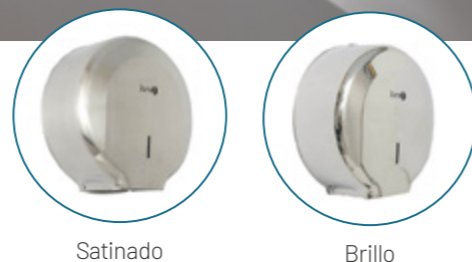

Satinado Brillo



Sol

Dispensador de papel higiénico industrial en acero inoxidable.

- ▶ Fabricado en acero resistente a la corrosión.
- ▶ Visor de nivel de carga.
- ▶ Cerradura con llave.
- ▶ Antivandálico.

Referencia	Color	U. / Caja
DP166AIS0	Satinado	6
DP166AIN0	Negro	6

- 262 mm
- 266 mm
- 122 mm



Dallas

Dispensador de papel higiénico doméstico en acero inoxidable Aisi 304.

- ▶ Fabricado en acero resistente a la corrosión.
- ▶ Encastrable; idóneo para obra nueva.
- ▶ Apropiado para colectividades.



Referencia	Color	U. / Caja
DP410AIB0	Brillo	24

- 150 mm
- 165 mm
- 122 mm



Secur

Dispensador de papel higiénico doméstico doble en acero inoxidable Aisi 304.

- ▶ Fabricado en acero resistente a la corrosión.
- ▶ Diseño elegante en acabado brillo.
- ▶ Apropiado para colectividades.

Referencia	Color	U. / Caja
DP149AIS0	Satinado	24

- 125 mm
- 120 mm
- 120 mm



Cáspier

Dispensador de papel higiénico industrial en policarbonato con extracción central o superior.

- ▶ Fabricado en polipropileno de alta resistencia.
- ▶ Producto apropiado para colectividades.



- 269 mm
- 258 mm
- 163 mm

Referencia	Extracción	Color	Papel	U. / Caja
DP250ABW0	Central	Translúcido	Rollo higiénico especial canuto desmontable de medidas máximas Ø200 mm y ancho 135 mm.	20
DP251ABW0	Superior	Translúcido	Rollo higiénico especial de medidas máximas Ø200 mm y ancho 135 mm.	20



Cuzco

Dispensador de papel toalla en acero inoxidable.

- ▶ Fabricado en acero resistente a la corrosión.
- ▶ Visor de nivel de carga.
- ▶ Apropiado para colectividades.
- ▶ Cerradura con llave.
- ▶ Antivandálico.

Referencia	Color	U. / Caja	
DP123AIS0	Satinado	6	252 mm
DP124AIB0	Brillo	6	332 mm
DP135ACW0	Epoxi Blanco	6	126 mm
DP123AIN0	Negro	6	



Veleta

Dispensador de papel toalla engarzada en ABS.

- ▶ Diseño único y atractivo.
- ▶ Visor de nivel de carga.
- ▶ Apropiado para colectividades.

271 mm 352 mm 135 mm

Referencia	Color	U. / Caja
DP211ABW0	Blanco	12
DP211ABN0	Negro	12

Ahora también en color negro



Bengoa

Dispensador de papel toalla en acero inoxidable.

- ▶ Fabricado en acero resistente a la corrosión.
- ▶ Visor de nivel de carga.
- ▶ Cerradura con llave.
- ▶ Antivandálico.

Referencia	Color	U. / Caja
DP167AIS0	Satinado	6
DP167AIN0	Negro	6



282 mm
265 mm
102 mm



Donosti

Dispensador de papel toalla en ABS.

- ▶ Diseño único y atractivo.
- ▶ Visor de nivel de carga.
- ▶ Apropiado para colectividades.

285 mm 385 mm 130 mm

Referencia	Color	U. / Caja
DP182ABW0	Blanco	1
DP182ABN0	Negro	1



Muralex

Dispensador de papel toalla mural en acero inoxidable Aisi 304

- ▶ Fabricado en acero resistente a la corrosión.
- ▶ Cerradura con llave.
- ▶ Encastrable: idóneo para obra nueva.

Referencia	Color	U. / Caja
DP835AIS0	Satinado	1



324 mm
437 mm
102 / 5 mm



New Cortex

Dispensador de papel autocorte en ABS.

- ▶ Cierre de seguridad
- ▶ Apropiado para colectividades
- ▶ Apto para papel sin precorte

NUEVO



Referencia	Color	U. / Caja
DP323ABW0	Blanco	1

- 286 mm
- 337 mm
- 184 mm



Rex

Dispensador de papel mecha en acero inoxidable.

- ▶ Fabricado en acero resistente a la corrosión.
- ▶ Apropiado para colectividades.
- ▶ Cerradura con llave.
- ▶ Antivandálico.



Referencia	Color	U. / Caja
DP638AIS0	Satinado	4
DP982AIB0	Brillo	4

- 215 mm
- 370 mm
- 215 mm

Bobina y Equipos Compactos



Roler Pared

Dispensador de papel bobina metálico en epoxi. Fijación a pared.

- ▶ Estructura metálica.
- ▶ Apropiado para colectividades, talleres y ambientes industriales.
- ▶ Corte preciso gracias a la sierra y el sistema de muelle que incorpora.
- ▶ Instalación mural para ahorrar espacio.

Referencia	Color	U. / Caja
DP138SDI0	Metálico/Gris	1

- 400 mm
- 420 mm
- 280 mm



Roler Suelo

Dispensador de papel bobina metálico en epoxi. Con apoyo a suelo.

- ▶ Estructura metálica.
- ▶ Apropiado para colectividades, talleres y ambientes industriales.
- ▶ Corte preciso gracias a la sierra y el sistema de muelle que incorpora.
- ▶ Soporte trípode para disponer del papel en cualquier lugar que necesite.
- ▶ Tubo de resistencia de 22mm de diámetro.

Referencia	Color	U. / Caja
DP137SDI0	Metálico/Gris	1

- 410 mm
- 800 mm
- 380 mm



Veleta

Dispensador de papel mecha en ABS.

- ▶ Diseño único y atractivo.
- ▶ Visor de nivel de carga.
- ▶ Apropiado para colectividades.

- 215 mm
- 297 mm
- 230 mm

Referencia	Color	U. / Caja
DP212ABW0	Blanco	12
DP212ABN0	Negro	12

NUEVO



Donosti

Dispensador de papel mecha en ABS.

- ▶ Diseño único y atractivo.
- ▶ Visor de nivel de carga.
- ▶ Apropiado para colectividades.

- 240 mm
- 380 mm
- 225 mm

Referencia	Color	U. / Caja
DP181ABW0	Blanco	1
DP181ABN0	Negro	1
DP181ABF0	Translúcido	1

Secamanos automático Blanco.



SM836ABW0

Dosificador de Jabón o espuma con pulsador en ABS de 1L.



Gel - DJ212ABW0
Espuma - DJ210ABW0

Dispensador de papel higiénico industrial en ABS.



DP210ABW0

Dispensador de papel toalla engarzada en ABS.



DP211ABW0

Dispensador de papel mecha en ABS.



DP212ABW0



SM839AIN0



Gel - DJ212ABN0
Espuma - DJ210ABN0



DP210ABN0



DP211ABN0



DP212ABN0

Línea VELETA

"Línea idónea en calidad/precio para cualquier tipo de colectividad. Especialmente recomendada para negocios de hostelería que buscan el mejor precio cuidando la imagen y productividad de su establecimiento".

VELETA

Secamanos automático Blanco.



SM805ACW0

Dosificador de Jabón o espuma con pulsador en ABS de 1L.



Gel - DJ180ABW0
Espuma - DJ181ABW0

Dispensador de papel higiénico industrial en ABS.



DP180ABW0

Dispensador de papel toalla engarzada en ABS.



DP182ABW0

Dispensador de papel mecha en ABS.



DP181ABW0



SM801AIN0



Gel - DJ180ABN0
Espuma - DJ181ABN0



DP180ABN0



DP182ABN0



DP181ABN0

Línea **DONOSTI**

"Línea que busca la calidad y la diferenciación mediante una gama de equipamiento muy competitiva. Idónea para cualquier uso medio e intensivo en diferentes tipos de colectividades como centros hospitalarios y geriátricos, centros de educación y residencias, centros de ocio y hoteles".

DONOSTI



Ver
productos



Accesorios de Baño

El baño debe ofrecer comodidad y bienestar al usuario. Escoger un equipamiento de baño práctico y funcional te permitirá crear un ambiente perfecto.

Se entiende accesorio como un elemento auxiliar que complementa a otro principal, pero lo cierto es que, en interiorismo, en muchas ocasiones los accesorios juegan un papel protagonista. En particular, en muchos diseños para baño son los accesorios los que reportan coherencia y armonía estética, y un toque distintivo que eleva al espacio a otra dimensión.



- ▶ Acero inoxidable Aisi 304
- ▶ Facilidad de instalación y limpieza.
- ▶ Apropiado para colectividades.
- ▶ Incluye tornillería: fácil de instalar y operar.

Línea GRANITO

Durabilidad
y Resistencia

Línea GRANITO



Toallero Repisa

Acero inoxidable Aisi 304

Referencia	Color	U. / Caja
AB001AIS1	Satinado	25
AB001AIB1	Brillo	25

- 575 mm
- 51 mm
- 211 mm



Toallero Repisa con Colgador

Acero inoxidable Aisi 304

Referencia	Color	U. / Caja
AB002AIS1	Satinado	25
AB002AIB1	Brillo	25

- 575 mm
- 135 mm
- 211 mm



Jabonera Baño con Drenaje

Acero inoxidable Aisi 304

Referencia	Color	U. / Caja
AB007AIS1	Satinado	72
AB007AIB1	Brillo	72

- 111 mm
- 51 mm
- 110 mm

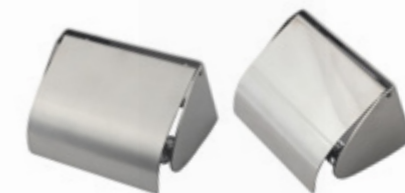

Portarrollos con Tapa

Acero inoxidable Aisi 304

Referencia	Color	U. / Caja
AB010AIS1	Satinado	30
AB010AIB1	Brillo	30

- 136 mm
- 69 mm
- 110 mm



Toallero Barra

Acero inoxidable Aisi 304

Referencia	Color	U. / Caja
AB004AIS1	Satinado	25
AB004AIB1	Brillo	25

- 495 mm
- 51 mm
- 87 mm



Toallero de Anilla

Acero inoxidable Aisi 304

Referencia	Color	U. / Caja
AB003AIS1	Satinado	50
AB003AIB1	Brillo	50

- 130 mm
- 145 mm
- 63 mm



Portarrollos Superficie

Acero inoxidable Aisi 304

Referencia	Color	U. / Caja
AB009AIS1	Satinado	36
AB009AIB1	Brillo	36

- 162 mm
- 162 mm
- 90 mm



Portarrollos Empotrable

Acero inoxidable Aisi 304

Referencia	Color	U. / Caja
AB012AIS1	Satinado	36
AB012AIB1	Brillo	36

- 162 mm
- 162 mm
- 37 mm



Percha Doble

Acero inoxidable Aisi 304

Referencia	Color	U. / Caja
AB006AIB1	Brillo	150

- 104 mm
- 51 mm
- 46 mm



Portarrollos sin Tapa

Acero inoxidable Aisi 304

Referencia	Color	U. / Caja
AB008AIB1	Brillo	72

- 206 mm
- 51 mm
- 98 mm



Escobillero Pared/Suelo

Acero inoxidable Aisi 304

Referencia	Color	U. / Caja
AB011AIS1	Satinado	12
AB011AIB1	Brillo	12

- 268 + 115 mm
- 95 mm

- ▶ Acero inoxidable Aisi 304
- ▶ Durabilidad y resistencia.
- ▶ Acabado brillo muy elegante.
- ▶ Facilidad de instalación y limpieza.
- ▶ Apropiado para colectividades.
- ▶ Incluye tornillería: fácil de instalar y operar.

Línea TITANIA

Posibilidad de otros colores

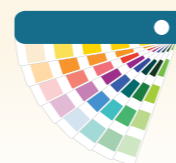

Línea TITANIA



Toallero Barra

Acero inoxidable Aisi 304

- ∅ 19 mm
- 493 mm
- 55 mm
- 78 mm

Referencia	Color	U. / Caja
AB145AIB1	Brillo	24



Toallero de Anilla

Acero inoxidable Aisi 304

- ∅ 9 mm
- 180 mm
- 202 mm
- 50 mm

Referencia	Color	U. / Caja
AB210AIB1	Brillo	30



Portarrollos Horizontal

Acero inoxidable Aisi 304

- ∅ 19 mm
- 180 mm
- 55 mm
- 75 mm

Referencia	Color	U. / Caja
AB147AIB1	Brillo	20



Portarrollos reserva

Acero inoxidable Aisi 304

- ∅ 19 mm
- 55 mm
- 248 mm
- 119 mm

Referencia	Color	U. / Caja
AB214AIB1	Brillo	50



Manillón

Acero inoxidable Aisi 304

- ∅ 25 mm
- 55 mm
- 78 mm

Referencia	Color	U. / Caja
30cm - AB530AIB1	Brillo	24
45cm - AB545AIB1	Brillo	24



Manillón Angular

Acero inoxidable Aisi 304

- ∅ 25 mm
- 448 mm
- 230 mm
- 80 mm

Referencia	Color	U. / Caja
AB501AIB1	Brillo	12



Portarrollos con Tapa

Acero inoxidable Aisi 304

- 165 mm
- 137 mm
- 50 mm

Referencia	Color	U. / Caja
AB206AIB1	Brillo	30



NUEVO

Escobilla de pared/suelo

Acero inoxidable Aisi 304

- ∅ 90mm
- 374 mm

Referencia	Color	U. / Caja
AB133AIB1	Brillo	20



Percha Doble

Acero inoxidable Aisi 304

- 64 mm
- 55 mm
- 67 mm

Referencia	Color	U. / Caja
AB207AIB1	Brillo	45



Tendedor Retráctil

Acero inoxidable Aisi 304

- ∅ 92 mm
- 53 mm

Referencia	Color	U. / Caja
AB132AIB1	Brillo	48

Pictogramas

Acero inoxidable. Fijación adhesiva. Acabado satinado. Consultar disponibilidad de otros pictogramas



AB086AIS1



AB087AIS1



AB088AIS1



AB089AIS1



AB090AIS1

- 120 mm
- 120 mm

- ▶ Acero inoxidable Aisi 304
- ▶ Durabilidad y resistencia.
- ▶ Excelente relación calidad/precio.
- ▶ Facilidad de instalación y limpieza.
- ▶ Apropiado para colectividades.
- ▶ Incluye tornillería: fácil de instalar y operar.

Posibilidad de otros colores



Línea ZAFIRO

Línea ZAFIRO



Toallero Repisa con Colgador

Acero inoxidable Aisi 304

Referencia	Color	U. / Caja
AB121AIS1	Satinado	10
AB121AIN1	Negro	10



Toallero Barra

Acero inoxidable Aisi 304

Referencia	Color	U. / Caja
AB120AIS1	Satinado	24
AB120AIN1	Negro	24

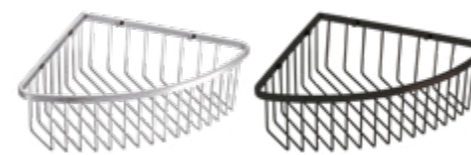

Jabonera Baño Triangular

Acero inoxidable Aisi 304

Referencia	Color	U. / Caja
AB127AIS1	Satinado	20
AB127AIN1	Negro	20

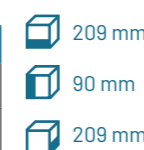

Portarrollos Horizontal

Acero inoxidable Aisi 304

Referencia	Color	U. / Caja
AB131AIS1	Satinado	20
AB131AIN1	Negro	20



Toallero de Anilla

Acero inoxidable Aisi 304

Referencia	Color	U. / Caja
AB123AIS1	Satinado	24
AB123AIN1	Negro	24



Percha Individual

Acero inoxidable Aisi 304

Referencia	Color	U. / Caja
AB124AIS1	Satinado	24
AB124AIN1	Negro	24



Portarrollos con Tapa

Acero inoxidable Aisi 304

Referencia	Color	U. / Caja
AB122AIS1	Satinado	24
AB122AIN1	Negro	24

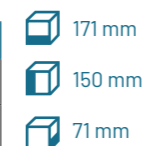

Portarrollos Reserva

Acero inoxidable Aisi 304

Referencia	Color	U. / Caja
AB126AIS1	Satinado	24
AB126AIN1	Negro	24



Percha Doble

Acero inoxidable Aisi 304

Referencia	Color	U. / Caja
AB125AIS1	Satinado	24
AB125AIN1	Negro	24



Jaboneras Baño

Acero inoxidable Aisi 304

Referencia	Color	U. / Caja
12cm - AB128AIS1	Satinado	24
12cm - AB128AIN1	Negro	24
30cm - AB129AIS1	Satinado	20
30cm - AB129AIN1	Negro	20



Escobillero Pared

Acero inoxidable Aisi 304

Referencia	Color	U. / Caja
AB130AIS1	Satinado	20
AB130AIN1	Negro	20



Escobillero Pared/Suelo

Acero inoxidable Aisi 304

Referencia	Color	U. / Caja
AB015AIS1	Satinado	20
AB015AIN1	Negro	20



- ▶ Acero inoxidable.
- ▶ Durabilidad y resistencia.
- ▶ Excelente relación calidad/precio.
- ▶ Facilidad de instalación y limpieza.
- ▶ Apropiado para colectividades.
- ▶ Incluye tornillería: fácil de instalar y operar.

**Durabilidad
y Resistencia**



Línea ANDALUCITA

Línea ANDALUCITA



Toallero Repisa con Colgador

Acero inoxidable.

Referencia	Color	U. / Caja
AB161AIS1	Satinado	10
AB161AIB1	Brillo	10

- 540 mm
- 113 mm
- 217 mm



Toallero Barra 60cm

Acero inoxidable.

Referencia	Color	U. / Caja
AB164AIS1	Satinado	24
AB164AIB1	Brillo	24

- 641 mm
- 46 mm
- 67 mm



Percha Individual

Acero inoxidable.

Referencia	Color	U. / Caja
AB168AIS1	Satinado	45
AB168AIB1	Brillo	45

- 50 mm
- 50 mm
- 47 mm



Percha Gancho

Acero inoxidable.

Referencia	Color	U. / Caja
AB166AIS1	Satinado	45
AB166AIB1	Brillo	45

- 46 mm
- 68 mm
- 72 mm



Toallero Barra 45cm

Acero inoxidable.

Referencia	Color	U. / Caja
AB163AIS1	Satinado	24
AB163AIB1	Brillo	24

- 488 mm
- 46 mm
- 67 mm



Toallero de Barra 30cm

Acero inoxidable.

Referencia	Color	U. / Caja
AB162AIS1	Satinado	24
AB162AIB1	Brillo	24

- 336 mm
- 46 mm
- 67 mm



Portarrollos con Tapa

Acero inoxidable.

Referencia	Color	U. / Caja
AB167AIS1	Satinado	50
AB167AIB1	Brillo	50

- 144 mm
- 123 mm
- 68 mm



Portarrollos Horizontal

Acero inoxidable.

Referencia	Color	U. / Caja
AB160AIS1	Satinado	50
AB160AIB1	Brillo	50

- 176 mm
- 46 mm
- 72 mm



Toallero de Anilla

Acero inoxidable.

Referencia	Color	U. / Caja
AB165AIS1	Satinado	30
AB165AIB1	Brillo	30

- 200 mm
- 218 mm
- 68 mm



Portarrollos Reserva

Acero inoxidable.

Referencia	Color	U. / Caja
AB140AIS1	Satinado	50
AB140AIB1	Brillo	50

- 46 mm
- 176 mm
- 72 mm

Línea ÓPALO

- ▶ Latón Cromado.
- ▶ Máxima resistencia a la oxidación.
- ▶ Acabado brillo muy elegante.
- ▶ Facilidad de instalación y limpieza.
- ▶ Apropiado para colectividades.
- ▶ Incluye tornillería: fácil de instalar y operar.



Gama de alta resistencia
Accesorios fabricados de una sola pieza

Línea ÓPALO



Toallero Repisa con Colgador

Latón cromado.

- ∅ 8/12 mm
- 520 mm
- 117 mm
- 255 mm

Referencia	Color	U. / Caja
AB203LTC1	Cromado	8



Toallero Barra 65cm

Latón cromado.

- ∅ 20 mm
- 650 mm
- 50 mm
- 87 mm

Referencia	Color	U. / Caja
AB460LTC1	Cromado	25



Manillón 35cm

Latón cromado.

- ∅ 25 mm
- 350 mm
- 50 mm
- 74 mm

Referencia	Color	U. / Caja
AB430LTC1	Cromado	25



Manillón 50cm

Latón cromado.

- ∅ 25 mm
- 533 mm
- 50 mm
- 74 mm

Referencia	Color	U. / Caja
AB445LTC1	Cromado	25



Toallero Barra 50cm

Latón cromado.

- ∅ 20 mm
- 497 mm
- 50 mm
- 87 mm

Referencia	Color	U. / Caja
AB446LTC1	Cromado	25



Toallero de Barra 35cm

Latón cromado.

- ∅ 20 mm
- 350 mm
- 50 mm
- 87 mm

Referencia	Color	U. / Caja
AB431LTC1	Cromado	25



Manillón Angular con Jabonera

Latón cromado.

- ∅ 25 mm
- 488 mm
- 46 mm
- 67 mm

Referencia	Color	U. / Caja
AB206LTC1	Cromado	12



Manillón Angular

Latón cromado.

- ∅ 25 mm
- 336 mm
- 46 mm
- 67 mm

Referencia	Color	U. / Caja
AB205LTC1	Cromado	12



Toallero Anilla

Latón cromado.

- ∅ 16 mm
- 227 mm
- 175 mm
- 72 mm

Referencia	Color	U. / Caja
AB210LTC1	Cromado	20



Percha Individual

Latón cromado.

- ∅ 20 mm
- 50 mm
- 80 mm
- 64 mm

Referencia	Color	U. / Caja
AB213LTC1	Cromado	48



Percha Doble

Latón cromado.

- ∅ 20 mm
- 162 mm
- 50 mm
- 68 mm

Referencia	Color	U. / Caja
AB214LTC1	Cromado	40

Línea ÓPALO

- ▶ Latón Cromado.
- ▶ Máxima resistencia a la oxidación.
- ▶ Acabado brillo muy elegante.
- ▶ Facilidad de instalación y limpieza.
- ▶ Apropiado para colectividades.
- ▶ Incluye tornillería: fácil de instalar y operar.



Gama de alta resistencia
Accesorios fabricados de una sola pieza

Línea ÓPALO



Jabonera Baño Cristal

Latón cromado.

- ∅ 109 mm
- 109 mm
- 50 mm
- 138 mm

Referencia	Color	U. / Caja
AB215LTC1	Cromado	30



Jabonera Baño Cuadrada

Latón cromado.

- 160 mm
- 38 mm
- 100 mm

Referencia	Color	U. / Caja
AB278LTC1	Cromado	50



Jabonera Baño Rectangular

Latón cromado.

- 215 mm
- 43 mm
- 120 mm

Referencia	Color	U. / Caja
AB277LTC1	Cromado	20



Jabonera Baño Triangular

Latón cromado.

- 250 mm
- 80 mm
- 150 mm

Referencia	Color	U. / Caja
AB077LTC1	Cromado	50



Espejo de Aumento Redondo

Latón cromado. Aumento (3x)

Referencia	Color	U. / Caja
AB104LTC1	Cromado	10

- 433 mm
- 298 mm
- 33 mm
- ∅ 200 mm



Portarrollos con Tapa

Latón cromado.

- 145 mm
- 124 mm
- 60 mm

Referencia	Color	U. / Caja
AB158LTC1	Cromado	24



Portarrollos Horizontal

Latón cromado.

- ∅ 20 mm
- 178 mm
- 50 mm
- 88 mm

Referencia	Color	U. / Caja
AB220LTC1	Cromado	50



Portarrollos Reserva

Latón cromado.

- ∅ 20 mm
- 50 mm
- 183 mm
- 100 mm

Referencia	Color	U. / Caja
AB212LTC1	Cromado	50



Portavasos de Cristal

Latón cromado.

- ∅ 70 mm
- 66 mm
- 95 mm
- 116 mm

Referencia	Color	U. / Caja
AB216LTC1	Cromado	30

- ▶ Latón Cromado.
- ▶ Máxima resistencia a la oxidación.
- ▶ Acabado brillo muy elegante.
- ▶ Facilidad de instalación y limpieza.
- ▶ Apropiado para colectividades.
- ▶ Incluye tornillería: fácil de instalar y operar.

Posibilidad de otros colores



Línea SIDERITA



Toallero Repisa con Colgador

Latón cromado.

Referencia	Color	U. / Caja
AB329LTC1	Cromado	10
AB329LTN1	Negro	10

- 525 mm
- 142 mm
- 230 mm

∅ 12 mm



Toallero Repisa con Colgador

Latón cromado.

Referencia	Color	U. / Caja
AB328LTC1	Cromado	10
AB328LTN1	Negro	10

- 530 mm
- 110 mm
- 235 mm

∅ 12 mm



Toallero Barra 60

Latón cromado.

Referencia	Color	U. / Caja
AB332LTC1	Cromado	24
AB332LTN1	Negro	24

- 16 mm
- 634 mm
- 50 mm
- 80 mm



Toallero Barra 45

Latón cromado.

Referencia	Color	U. / Caja
AB331LTC1	Cromado	24
AB331LTN1	Negro	24

- 16 mm
- 484 mm
- 50 mm
- 80 mm



Toallero Barra 30

Latón cromado.

Referencia	Color	U. / Caja
AB330LTC1	Cromado	24
AB330LTN1	Negro	24

- 16 mm
- 334 mm
- 50 mm
- 80 mm



Espejo de Aumento Rectangular

Latón cromado. Aumento (3x)

Referencia	Color	U. / Caja
AB324LTC1	Cromado	10

- 451 mm
- 232 mm
- 70 mm



Gama de alta resistencia
Accesorios fabricados de una sola pieza

Línea SIDERITA

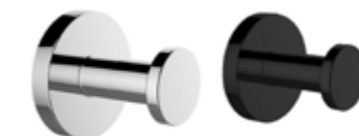

Percha Individual

Latón cromado.

Referencia	Color	U. / Caja
AB325LTC1	Cromado	45
AB325LTN1	Negro	45

- 50 mm
- 50 mm
- 50 mm



Percha Gancho

Latón cromado.

Referencia	Color	U. / Caja
AB322LTC1	Cromado	45
AB322LTN1	Negro	45

- 50 mm
- 87 mm
- 80 mm



Portarrollos con Tapa

Latón cromado.

Referencia	Color	U. / Caja
AB327LTC1	Cromado	30
AB327LTN1	Negro	30

- 122 mm
- 125 mm
- 139 mm



Portarrollos Horizontal

Latón cromado.

Referencia	Color	U. / Caja
AB326LTC1	Cromado	50
AB326LTN1	Negro	50

- 16 mm
- 207 mm
- 50 mm
- 90 mm



NUEVO

Espejo de Aumento Redondo

Latón cromado. Aumento (3x)

Referencia	Color	U. / Caja
AB104LTC1	Cromado	10
AB104LTN1	Negro	10

- 433 mm
- 298 mm
- 33 mm
- 200 mm



Portarrollos Reserva

Latón cromado.

Referencia	Color	U. / Caja
AB320LTC1	Cromado	50
AB320LTN1	Negro	50

- 50 mm
- 212 mm
- 88 mm
- 16 mm



Espejo Velux

Espejo rectangular con marco en ABS Blanco

- ▶ Diseño práctico y funcional.
- ▶ Fácil mantenimiento.
- ▶ Marco estrecho.

Referencia	Color	U. / Caja
AB630ABW1	Blanco	4

- 550 mm
- 650 mm
- 40 mm



Espejo Sevilla

Espejo rectangular con marco en aluminio Satinado

- ▶ Diseño práctico y funcional.
- ▶ Fácil mantenimiento y máxima resistencia a la oxidación.
- ▶ Marco estrecho fabricado en aluminio.

Referencia	Medida	Color	U. / Caja
AB030SDI1	50x70cm	Satinado	1
AB031SDI1	60x80cm	Satinado	1



Take

Dispensador de bolsitas

- ▶ Diseño elegante y funcional.
- ▶ Fácil mantenimiento y máxima resistencia a la oxidación.
- ▶ Fabricado en Acero inoxidable.
- ▶ Colocación sobre encimera o mural.



Referencia	Color	U. / Caja
AB970AIS1	Satinado	50
AB969AIB1	Brillo	30
AB970AIN1	Negro	50
AB967ABC1	ABS Cromado	50

- 140 mm
- 27mm
- 100 mm



Zero

Dispensador de toallitas

- ▶ Diseño elegante y funcional.
- ▶ Fácil mantenimiento.
- ▶ Colocación sobre encimera o mural.
- ▶ Fabricado en acero inoxidable Aisi 304.



Referencia	Color	U. / Caja
AB911AIS1	Satinado	40
AB911AIB1	Brillo	40
AB911AIN1	Negro	40

- 252 mm
- 74 mm
- 128 mm



Thermo

Toallero de Agua o Eléctrico

- ▶ Diseño elegante y funcional.
- ▶ Fácil mantenimiento.
- ▶ Seca las toallas a la par que calienta la estancia.
- ▶ Inhibe la proliferación de bacterias en las toallas.
- ▶ Ideal para su uso tanto en lugares públicos como en el hogar.
- ▶ Incluye tornillería y soporte a pared.
- ▶ Fácil de instalar y operar.

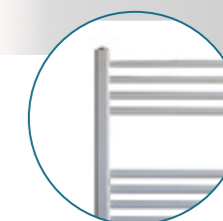

Blanco

	Referencia	Color	Medida	Potencia	Barras Tubulares	U. / Caja
Agua	AB708WAW0	Blanco	500 x 800 x 100 mm	300W	13	1
	AB708WAC0	Cromado	500 x 800 x 100 mm	250W	13	1
	AB712WAW0	Blanco	500 x 1200 x 100 mm	475W	21	1
	AB712WAC0	Cromado	500 x 1200 x 100 mm	375W	21	1
	AB715WAW0	Blanco	500 x 1500 x 100 mm	634W	29	1
	AB715WAC0	Cromado	500 x 1500 x 100 mm	500W	29	1
Eléctrico	AB708CAW0	Blanco	500 x 800 x 100 mm	300W	13	1
	AB708CAC0	Cromado	500 x 800 x 100 mm	250W	13	1
	AB712CAW0	Blanco	500 x 1200 x 100 mm	475W	21	1
	AB712CAC0	Cromado	500 x 1200 x 100 mm	375W	21	1
	AB715CAW0	Blanco	500 x 1500 x 100 mm	634W	29	1
	AB715CAC0	Cromado	500 x 1500 x 100 mm	500W	29	1



Lavamanos mural pulsador de rodilla

Lavamanos mural con pulsador rodilla en acero inoxidable Aisi 304
Agua fría y caliente.

- ▶ Fabricada en acero AISI 304
- ▶ Accionamiento con la rodilla.
- ▶ Ideal para instalaciones con espacio reducido.
- ▶ Dispone de una válvula mezcladora anti retorno con la que se regula la temperatura.
- ▶ Incluye tornillería y soporte a pared.
- ▶ Fácil de instalar y operar.

Referencia	Color	U. / Caja
SA120AIS1	Satinado	1

- ▶ 350 mm
- ▶ 215 + 200 mm
- ▶ 300 mm



Lavamanos encimera con rebosadero

Lavamanos para encimera con rebosadero en acero inoxidable de

- ▶ Fabricado en acero AISI 304
- ▶ Terminación curva para facilitar el encastre a la encimera.
- ▶ Ideal para aseos públicos por su robustez y diseño anti-vandálico.
- ▶ Fácil mantenimiento y limpieza.
- ▶ Incluye tornillería y soporte a pared.
- ▶ Fácil de instalar y operar.

Referencia	Diametro interior/exterior	Color	U. / Caja
SA036AIB1	313 mm / 357 mm	Brillo	1
SA041AIB1	359 mm / 405 mm	Brillo	1



Lavamanos encimera sin rebosadero

Lavamanos para encimera sin rebosadero en acero inoxidable

- ▶ Fabricado en acero AISI 304
- ▶ Terminación curva para facilitar el encastre a la encimera.
- ▶ Ideal para aseos públicos por su robustez y diseño anti-vandálico.
- ▶ Fácil mantenimiento y limpieza.
- ▶ Incluye tornillería y soporte a pared.
- ▶ Fácil de instalar y operar.

Referencia	Diametro interior/exterior	Color	U. / Caja
SA536AIB1	313 mm / 359 mm	Brillo	1
SA541AIB1	359 mm / 405 mm	Brillo	1



Lavamanos de pie con pulsador

Lavamanos de pie con pulsador en acero inoxidable Aisi 304.
Agua fría y caliente.

- ▶ Fabricada en acero AISI 304
- ▶ Válvula mezcladora anti retorno que permite regular la temperatura
- ▶ Tapa delantera registrable y fácilmente extraíble
- ▶ Incluye tornillería y soporte a pared.
- ▶ Fácil de instalar y operar.

Referencia	Pulsadores	Color	U. / Caja
SA119AIS1	1	Satinado	1
SA118AIS1	2	Satinado	1

- ▶ 450 mm
- ▶ 850 + 223 mm
- ▶ 450 mm



Dos Pulsadores



Ver
productos



Baños Adaptados

El acondicionamiento y adaptación de baños y aseos para personas con discapacidad es muy importante, ya que es sinónimo de comodidad, autosuficiencia y seguridad en su día a día. Saber cómo adaptar baños es, por lo tanto, garantía de tranquilidad y bienestar.

La barra de apoyo abatible de acero inoxidable es un dispositivo especialmente diseñado para el baño, pensado para complementar un bidé o inodoro, que aumenta la autonomía y la seguridad de las personas mayores y/o con movilidad reducida, evitando el riesgo de caídas y proporcionando un apoyo imprescindible durante el aseo.





Claus 60

Barra de apoyo abatible vertical en acero inoxidable/ Acero acabado pintado. Con portarrollos y freno progresivo.

- ▶ Máxima resistencia a la oxidación
- ▶ Gran durabilidad y resistencia.
- ▶ Antivandálica.
- ▶ Portarrollos integrado.
- ▶ Freno progresivo

Referencia	Color	U. / Caja
BM603AIS0	Satinado	5
BM603ACW0	Blanco	5



Basil 80

Barra de apoyo abatible con columna fija en acero inoxidable Aisi 304 Con portarrollos y freno progresivo.

- ▶ Máxima resistencia a la oxidación.
- ▶ Gran durabilidad y resistencia.
- ▶ Cumple normativa CTE DB SUA.
- ▶ Antivandálica.
- ▶ Adecuado para proyectos con paredes de pladur.

Referencia	Color	U. / Caja
BM580AIS0	Satinado	1



Alysa 80

Barra de apoyo recta abatible con pata en acero inoxidable Aisi 304

- ▶ Fabricado en acero AISI 304.
- ▶ Abatida ocupa un espacio muy reducido.
- ▶ Máxima robustez. Antivandálica.

Referencia	Color	U. / Caja
BM808AIS0	Satinado	5



Adara 80

Barra de apoyo abatible vertical en acero inoxidable/ Acero acabado pintado. Con portarrollos y freno progresivo.

- ▶ Máxima resistencia a la oxidación
- ▶ Gran durabilidad y resistencia.
- ▶ Cumple normativa CTE DB SUA
- ▶ Antivandálica
- ▶ Freno progresivo

Referencia	Color	U. / Caja
BM800AIS0	Satinado	5
BM800AIB0	Brillo	5
BM800ACW0	Blanco	5
BM800AIN0	Negro	5



Satinado



Blanco



Negro



Delia

Barra de apoyo recta en Acero Inoxidable / Acero acabado pintado

- ▶ Máxima resistencia a la oxidación.
- ▶ Cumple normativa CTE DB SUA.
- ▶ Máxima robustez. Antivandálica.

∅ 32 mm

Referencia	Medida	Color	U. / Caja
BM030AIS0	30 cm	Satinado	20
BM030AIB0		Brillo	20
BM030ACW0		Blanco	20
BM040AIS0	40 cm	Satinado	20
BM040ACW0		Blanco	20
BM050AIS0	50 cm	Satinado	20
BM050AIB0		Brillo	20
BM050ACW0		Blanco	20
BM060AIS0	60 cm	Satinado	20
BM060ACW0		Blanco	20
BM075AIS0	75 cm	Satinado	20
BM075ACW0		Blanco	20
BM090AIS0	90 cm	Satinado	20
BM090ACW0		Blanco	20
BM120AIS0	120 cm	Satinado	20
BM120ACW0		Blanco	20



Deo

Barra de ángulo de 90° a pared con tres puntos de apoyo. En acero inoxidable Aisi 304 Satinado.

- ▶ Máxima resistencia a la oxidación.
- ▶ Máxima robustez. Antivandálica.
- ▶ Reversible para instalar en ambos sentidos

∅ 32 mm

577 mm

577 mm

76 mm

Referencia	Color	U. / Caja
BM338AIS0	Satinado	12



Aquiles

Barra de ángulo de 130° a pared en acero inoxidable Aisi 304 Satinado.

- ▶ Máxima resistencia a la oxidación.
- ▶ Máxima robustez. Antivandálica.

∅ 32 mm

590 mm

290 mm

76 mm

Referencia	Color	U. / Caja
BM130AIS0	Satinado	10



Cosmo

Barra de ángulo de 90 a pared con tres puntos de apoyo en Acero Inoxidable/Acero acabado pintado

- ▶ Máxima resistencia a la oxidación.
- ▶ Cumple normativa CTE DB SUA.
- ▶ Máxima robustez. Antivandálica.
- ▶ Reversible para instalar en ambos sentidos

∅ 32 mm

737 mm

638 mm

76 mm

Referencia	Lado	Color	U. / Caja
BM902AIS0	Derecho	Satinado	12
BM902ACW0	Derecho	Blanco	12
BM901AIS0	Izquierdo	Satinado	12
BM901ACW0	Izquierdo	Blanco	12



Ellen

Barra de apoyo a pared suelo de 90° en Acero Inoxidable / Acero acabado pintado.

- ▶ Máxima resistencia a la oxidación.
- ▶ Cumple normativa CTE DB SUA.
- ▶ Máxima robustez. Antivandálica.

∅ 32 mm

79 mm

773 mm

801 mm

Referencia	Color	U. / Caja
BM339AIS0	Satinado	12
BM350ACW0	Blanco	12



Aria

Barra de apoyo a pared suelo con tres puntos de anclaje y ángulo de 90° en Acero Inoxidable / Acero acabado pintado.

- ▶ Máxima resistencia a la oxidación.
- ▶ Cumple normativa CTE DB SUA.
- ▶ Máxima robustez. Antivandálica.
- ▶ Disponible en disposición izquierda o derecha.
- ▶ Doble apoyo a suelo.

Referencia	Lado	Color	U. / Caja
BM336AIS0	Derecho	Satinado	8
BM334ACW0	Derecho	Blanco	8
BM337AIS0	Izquierdo	Satinado	8
BM335ACW0	Izquierdo	Blanco	8

- 32 mm
- 228 mm
- 773 mm
- 800 mm



Egan

Barra de apoyo fija de tres puntos de anclaje en Acero Inoxidable / Acero acabado pintado en acero inoxidable Aisi 304

- ▶ Máxima resistencia a la oxidación.
- ▶ Cumple normativa CTE DB SUA.
- ▶ Máxima robustez. Antivandálica.
- ▶ Disponible en disposición izquierda o derecha.

Referencia	Lado	Color	U. / Caja
BM370AIS1	Derecho	Satinado	1
BM370ACW1	Derecho	Blanco	1
BM371AIS1	Izquierdo	Satinado	1
BM371ACW1	Izquierdo	Blanco	1

- 32 mm
- 205 mm
- 235 mm
- 700 mm



Goiko

Barra de apoyo horizontal a dos paredes de 90° en Acero Inoxidable / Acero acabado pintado

- ▶ Máxima resistencia a la oxidación.
- ▶ Cumple normativa CTE DB SUA.
- ▶ Máxima robustez. Antivandálica.

Referencia	Color	U. / Caja
BM970AIS0	Satinado	6
BM970ACW0	Blanco	6

- 32 mm
- 798 mm
- 78 mm
- 798 mm



personalización de productos

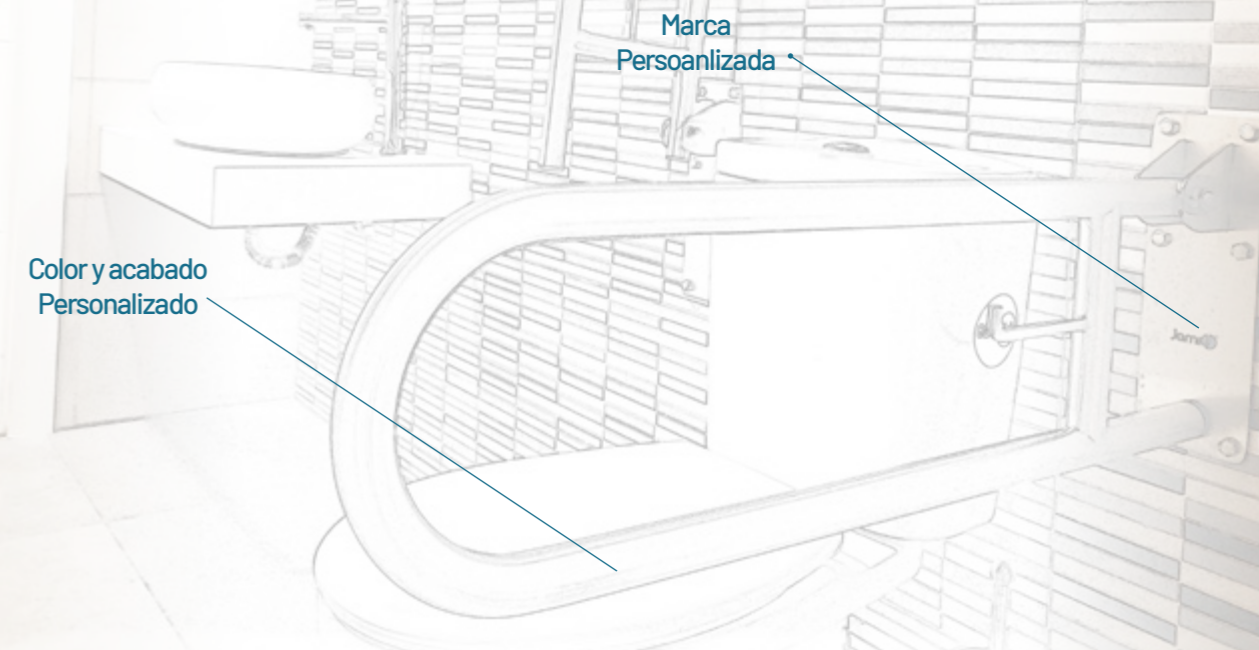

Estudiamos bajo consulta la personalización de productos, terminación, color marca en una amplia gama de artículos JAMIBRISAS

Consulte disponibilidad.
Sujeto a cantidades mínimas bajo pedido y condiciones técnicas de realización



Caesar

Asiento de ducha abatible en ABS Blanco.

- ▶ Fabricado en ABS antideslizante reforzado en aluminio.
- ▶ Cumple la normativa ADA.
- ▶ Material antibacteriano e ignífugo.
- ▶ Diseño plegable para ahorrar espacio cuando no esté en uso.

Referencia	Color	U. / Caja
AD988NYW1	Blanco	10

- 320 mm
- 104 mm
- 328 mm



Normativa ADA



Adonis

Asiento de ducha abatible en acero inoxidable Aisi 304 Satinado.

- ▶ Material resistente, duradero y de fácil limpieza.
- ▶ Diseño plegable y con bloqueo en posición vertical.

Referencia	Color	U. / Caja
AD222AIS1	Satinado	1

- 462 mm
- 100 mm
- 410 mm



Bergara

Asiento de ducha abatible con apoyo a suelo en acero inoxidable Aisi 304

- ▶ Material resistente, duradero y de fácil limpieza.
- ▶ Diseño plegable para ayudar a la movilidad del usuario.
- ▶ Doble apoyo a suelo para una mayor robustez.

Referencia	Color	U. / Caja
AD223AIS1	Satinado	1

- 462 mm
- 452 mm
- 410 mm



Troja

Asiento de ducha abatible con apoyo a suelo en aluminio anodizado poliéster Gris. Patas regulables en altura.

- ▶ Diseñado con formas cóncavas para dotarlo de una mayor estabilidad.
- ▶ Incluye orificios de desagüe que impiden que se acumule agua y suciedad.
- ▶ Apertura lateral para una mayor seguridad.
- ▶ Altura regulable.

Referencia	Color	U. / Caja
AD226SDI1	Gris	1

- 480 mm
- 390/540 mm
- 300+100 mm



Pretor

Asiento de ducha abatible con apoyo a pared en acero inoxidable Aisi 304 Satinado.

- ▶ Material resistente, duradero y de fácil limpieza.
- ▶ Apoyo central que actúa como refuerzo.
- ▶ Diseño plegable para ayudar a la movilidad del usuario.

Referencia	Color	U. / Caja
AD103AIS1	Satinado	1



- 450 mm
- 430 mm
- 430 mm



Zentro

Taburete de ducha en aluminio anodizado poliéster Blanco. Patas regulables en altura cada 2,2cm.

- ▶ Incluye orificios de desagüe que impiden que se acumule agua y suciedad.
- ▶ Incluye una goma antideslizante.
- ▶ Altura regulable cada 2.5cm para una óptima posición.
- ▶ Conteras preparadas para evitar accidentes por desplazamientos.
- ▶ Asiento ergonómico.

Referencia	Color	U. / Caja
AD224SDI1	Blanco	1

- 510 mm
- 440/580 mm
- 410 mm



Inodoro Perla

Inodoro de porcelana vitrificada blanca con abertura frontal.

- ▶ Cumple normativa CTE DB SUA.
- ▶ Apertura higiénica.
- ▶ Disponible con salida suelo o pared.
- ▶ Ergonómico y funcional.

Referencia	Salida	Color	U. / Caja
AM108CE1	a Suelo	Blanco	1
AM109CE1	a Pared	Blanco	1

380 mm

470 mm

580 mm



Alza Elora

Alza para inodoro con tapa y abertura frontal en polipropileno Blanco.

- ▶ Diseño adaptable a la mayoría de WC ovalados o cuadrados.
- ▶ Materiales en sintonía estética con el resto del baño.
- ▶ Fácil limpieza.
- ▶ Adaptado a personas con movilidad reducida.

Referencia	Color	U. / Caja
AM113SDI1 - Con Tapa	Blanco	1
AM114SDI1 - Sin Tapa	Blanco	1

410 mm

110 mm

420 mm



Asiento con tapa Perla

Asiento de inodoro con tapa en ABS Blanco y con abertura frontal para inodoro.

- ▶ Fabricado en MDF de máxima resistencia.
- ▶ Construcción robusta. Bisagras de acero.
- ▶ Fácil limpieza y bajo mantenimiento.
- ▶ Adaptado a personas con movilidad reducida.

Referencia	Color	U. / Caja
AM110SDI1	Blanco	1

380 mm

45 mm

450 mm



Asiento con tapa Keita

Asiento de inodoro con tapa en MDF Blanco. Abertura frontal para modelo Perla.

- ▶ Fabricado en MDF de máxima resistencia.
- ▶ Construcción robusta. Bisagras de acero.
- ▶ Fácil limpieza y bajo mantenimiento.
- ▶ Adaptado a personas con movilidad reducida.

Referencia	Color	U. / Caja
AM094SDI1	Blanco	1

380 mm

50 mm

470 mm



Cisterna Teka

Cisterna para inodoro en ABS Blanco de 9L con mando neumático.

- ▶ Dispone de mando neumático en posición libre.
- ▶ Apropiado para sitios públicos.
- ▶ Entrada de agua lateral.
- ▶ Fabricada en ABS.

Referencia	Color	U. / Caja
AM093ABI1	Blanco	1

440mm

400 mm

140 mm



Alza Vero

Alza para inodoro con tapa y abertura frontal en MDF Blanco.

- ▶ Máximo confort al usuario gracias a su elevación.
- ▶ Materiales en sintonía estética con el resto del baño.
- ▶ Fácil limpieza.
- ▶ Adaptado a personas con movilidad reducida.

Referencia	Color	U. / Caja
AM096SDI1	Blanco	1

370 mm

130 mm

420 mm



Cisterna Mural Selva

Cisterna mural en ABS Blanco de 3-6L. Doble descarga regulable con dos pulsadores.

- ▶ Dispone de doble pulsador.
- ▶ Ahorro de agua mediante descarga de 3/6 litros.
- ▶ Entrada de agua lateral izqda./dcha.
- ▶ Colocación en altura variable según necesidad.

Referencia	Color	U. / Caja
AM107SDI1	Blanco	1

380 mm

421 mm

128 mm



Alza Clara

Alza para inodoro sin tapa y abertura frontal en MDF Blanco.

- ▶ Máximo confort al usuario gracias a su elevación.
- ▶ Materiales en sintonía estética con el resto del baño.
- ▶ Fácil limpieza.
- ▶ Adaptado a personas con movilidad reducida.

Referencia	Color	U. / Caja
AM095SDI1	Blanco	1

370 mm

100 mm

420 mm



Libra

Lavabo para minusválidos en cerámica Blanco.

- ▶ Frontal cóncavo para facilitar el acceso con silla de ruedas.
- ▶ Fácil limpieza.
- ▶ Adaptado a personas con movilidad reducida.
- ▶ Diseño acanalado para una mejor evacuación del agua.

Referencia	Color	U. / Caja
AM097CEI1	Blanco	1

- ▶ 650 mm
- ▶ 230mm
- ▶ 570 mm



Saniti

Grifo de lavabo monomando con palanca clínica cromado.

- ▶ Fabricado en latón.
- ▶ Fácil limpieza.
- ▶ Adaptado a personas con movilidad reducida.
- ▶ Cumple normativa CTE DB SUA.

Referencia	Color	U. / Caja
AM111SDI1	Cromado	1

- ▶ 50 mm
- ▶ 160 mm
- ▶ 200 mm



Mar

Ménsulas fijas para lavabo en acero Blanco.

- ▶ Máxima resistencia.
- ▶ Fácil limpieza.
- ▶ Incluye tornillería: fácil de instalar y operar.

Referencia	Color	U. / Caja
AM098SDI1	Blanco	1

- ▶ 60 mm
- ▶ 140 mm
- ▶ 362 mm



Lope

Soporte reclinable manual para lavabo en acero Blanco.

- ▶ Máxima resistencia.
- ▶ Fácil limpieza.
- ▶ Adaptado a personas con movilidad reducida.
- ▶ Inclinación regulable.

Referencia	Color	U. / Caja
AM099SDI1	Blanco	1

- ▶ 580 mm
- ▶ 153 mm
- ▶ 390 mm



Omar

- ▶ Máxima resistencia. Fácil limpieza.
- ▶ Adaptado a personas con movilidad reducida.
- ▶ Inclinación regulable mediante mecanismo neumático.

Referencia	Color	U. / Caja
AM100SDI1	Blanco	1

- ▶ 574 mm
- ▶ 145 mm
- ▶ 435 mm



Elio

Espejo reclinable con marco en aluminio y plata anodizado.

- ▶ Cumple normativa CTE DB SUA.
- ▶ Fácil limpieza.
- ▶ Apto para baños y espacios adaptados.
- ▶ Adaptado a personas con movilidad reducida.
- ▶ Inclinación regulable.

Referencia	Marco	U. / Caja
AM126ALG1	Aluminio y Plata Anodizado	1

- ▶ 500 mm
- ▶ 700 mm



Korba

Espejo reclinable con marco en ABS Blanco.

- ▶ Cumple normativa CTE DB SUA.
- ▶ Apto para baños y espacios adaptados.
- ▶ Adaptado a personas con movilidad reducida.
- ▶ Inclinación regulable.

Referencia	Medidas	Marco	U. / Caja
AM120ABW1	50 x 60 cm	Blanco	1
AM121ABW1	60 x 70 cm	Blanco	1



Ibero

Espejo reclinable con marco en acero pulido.

- ▶ Cumple normativa CTE DB SUA.
- ▶ Apto para baños y espacios adaptados.
- ▶ Adaptado a personas con movilidad reducida.
- ▶ Inclinación regulable.

Referencia	Medidas	Marco	U. / Caja
AM124AIB1	50 x 70 cm	Acero inoxidable pulido	1
AM125AIB1	60 x 80 cm	Acero inoxidable pulido	1



Bera

Espejo reclinable sin marco con cristal de seguridad.

- ▶ Cumple normativa CTE DB SUA.
- ▶ Apto para baños y espacios adaptados.
- ▶ Adaptado a personas con movilidad reducida.
- ▶ Inclinación regulable.

Referencia	Medidas	Marco	U. / Caja
AM122SDI1	50 x 70 cm	Sin Marco	1
AM123SDI1	60 x 80 cm	Sin Marco	1

Ver productos



Mesas Cambiabebés

El acto de cambiar pañales es una de las principales tareas de los padres y madres que tienen bebés. En muchas ocasiones este cometido puede ocurrir fuera de nuestros hogares y en el interior de diferentes establecimiento o espacios comunes. En la actualidad, este proceso de limpieza puede ser rápido, seguro y fácil si se dispone de un cambia-pañales horizontal fiable y seguro.

La mesa cambiabebés es un mueble en el que se puede colocar al bebé de forma cómoda y segura para limpiarlo fácilmente. Ya que, al mismo tiempo, nos permite mantener los suministros en un solo lugar, como pañales, toallitas húmedas y otros accesorios.



- 895 mm
- 510 mm
- 100/490 mm

- 559 mm
- 900 mm
- 133/889 mm

Talia

Mesa cambiabebés abatible en polietileno de alta densidad.

- ▶ Fabricado en acero y HDPE para una máxima resistencia.
- ▶ Superficie rugosa antideslizante.
- ▶ Accionamiento neumático para un mayor confort.
- ▶ Dispone de cinturón de seguridad para el bebé.

Referencia	Orientación	U. / Caja
MC135POE0	Horizontal	1
MC137POE0	Vertical	1



Crema

Mesa cambiabebés abatible horizontal en polietileno de alta densidad.

- ▶ Fabricado en acero y HDPE para una máxima resistencia.
- ▶ Dispone de cinturón de seguridad para el bebé.
- ▶ Incluye pistón de alta calidad que permite la operación de apertura y cierre con una sola mano.
- ▶ Incluye compartimentos integrados para colocar papel y demás objetos necesarios.

Referencia	Color	U. / Caja
MC138POE1	Blanco Crema	1

- 856 mm
- 580 mm
- 100/510 mm



INOX

Mesa cambiabebés abatible horizontal en acero inoxidable Satinado.

- ▶ Fabricado en acero inoxidable.
- ▶ Superficie rugosa antideslizante.
- ▶ Accionamiento neumático para un mayor confort.
- ▶ Dispone de cinturón de seguridad para el bebé.

Referencia	Color	U. / Caja
MC139AIS1	Satinado	1

- 905 mm
- 520 mm
- 104/495mm



Baby

Contenedor de pañales con pedal en ABS Gris de 60L.

- ▶ Superficie lisa que permite una mejor limpieza.
- ▶ Accionamiento mediante pedal.
- ▶ Especialmente diseñado para evitar la visión de los desechos de su interior.

Referencia	Color	U. / Caja
PP009ABW1	Gris	1

- 440 mm
- 764 mm
- 416 mm



Ver
productos



Fuentes de Agua

La instalación de fuentes de agua en empresas ofrece numerosos beneficios. Promueve un ambiente saludable, reduce el consumo de botellas de agua y supone un ahorro en costes. Existen diversos tipos de fuentes de agua para empresas, como las de agua mineral natural, las filtradas por red y las con dispensador de agua caliente y fría.





Grifo pulsador Clio

Grifo pulsador para fuente Clio.

- ▶ Acabado resistente y elegante.
- ▶ Adecuado para un uso intensivo.
- ▶ Incluye tornillería: fácil de instalar y operar.

Referencia	Color	U. / Caja
RP700GRP1	Satinado	1

- 31 mm
- 113 mm
- 57 mm



Grifo rellenavasos Clio

Grifo rellenavasos para fuente Clio.

- ▶ Acabado resistente y elegante.
- ▶ Adecuado para el llenado de vasos y botellas de agua pequeñas.
- ▶ Incluye tornillería: fácil de instalar y operar.

Referencia	Color	U. / Caja
RP700GRR1	Satinado	1

- 28 mm
- 283 mm
- 82 mm



Dispensador

Dispensador de vasos desechables para fuente de agua en ABS transparente.

- ▶ Adaptado para las fuentes de Jami Brisass.
- ▶ Dispensador práctico y funcional.
- ▶ Plástico transparente para visualizar el nivel de carga.

Referencia	Color	U. / Caja
FA715SDI1	ABS Transparente	1

- 406 mm
- 81 mm



Hispalis

Fuente de agua para exterior sin pedal en acero ino. Aisi 304 Brillo.

- ▶ Fabricada en acero AISI 304.
- ▶ No necesita de corriente eléctrica para su funcionamiento.
- ▶ Terminación anti-abolladuras.

Referencia	Color	U. / Caja
FA708AIB1	Brillo	1

- 800 mm
- 345 mm



Clio

Fuente de agua refrigeradora en acero inoxidable Aisi 304. Depósito 4L.

- ▶ Fabricada en acero AISI 304.
- ▶ Agua de gran calidad gracias a sus 2 filtros.
- ▶ Acabado antivandálico.
- ▶ Doble grifo pulsador y rellena vasos.
- ▶ Capacidad de refrigeración de agua de 25 litros/hora.
- ▶ Depósito interior para almacenamiento de agua fría de 4L.

- 301 mm
- 1227 mm
- 307 mm

Referencia	Color	U. / Caja
FA700AIS0 - Sin Pedal	Satinado	1
FA720AIS0 - Con Pedal	Satinado	1

Recambios Filtros

Referencia	Descripción	U. / Caja	
RP700F1D2	Filtro Polipropileno	Elimina la arena, limo, suciedad, partículas de óxido, etc, en el agua.	1
RP700F2D2	Filtro Carbon Activo	Elimina materiales pesados, pesticidas, cloro, sabor, olor, etc, en el agua.	1



Ver
productos



Papeleras y Ceniceros

Las papeleras cumplen una función esencial, puesto que son la solución perfecta para conservar la limpieza e higiene de superficies y pavimentos. Se trata de la solución ideal para almacenar y recoger la basura de manera correcta y fácil favoreciendo así la recolección de residuos en establecimientos, negocios o incluso en la calle.

La recogida selectiva a través de papeleras de reciclaje en las empresas y negocios realmente tiene muchas ventajas. Basta un poco de atención diaria para conseguir un gran resultado colectivo que repercutirá en beneficios medioambientales y económicos.



Book



Papelera de baño en acero inoxidable de 6l. Cubo interior extraíble.

- ▶ Fabricada en Acero Inoxidable.
- ▶ Papelera de cierre amortiguado.
- ▶ Apertura higiénica con pedal.
- ▶ Su elegante diseño hace que se adapte fácilmente a todo tipo de baños.
- ▶ Fácil mantenimiento.
- ▶ Pedal de acero, robusto y duradero.
- ▶ Cubeta interior extraíble con asa, perfecta para un fácil vaciado y limpieza.
- ▶ Ideal para su uso tanto en lugares públicos como en el hogar.



Referencia	Color	U. / Caja
PP143ACN1	Negro	2
PP143AIS1	Satinado	2

- 200 mm
- 270 mm
- 260 mm



Luka

Papelera de baño en acero inoxidable. Cubo interior extraíble.

- ▶ Fabricada en Acero Inoxidable.
- ▶ Apertura higiénica con pedal.
- ▶ Su elegante diseño hace que se adapte fácilmente a todo tipo de baños.
- ▶ Fácil mantenimiento.
- ▶ Pedal de acero, robusto y duradero.
- ▶ Cubeta interior extraíble con asa, perfecta para un fácil vaciado y limpieza.
- ▶ Ideal para su uso tanto en lugares públicos como en el hogar.



Moka

Compresero con pedal en ABS Blanco de 18L. Tapa y pedal en gris.

- ▶ Fabricada en polipropileno y ABS.
- ▶ Apertura higiénica con pedal.
- ▶ Cabezal extraíble.
- ▶ Fácil mantenimiento.
- ▶ Balancín ciego y cavidad para productos higienizantes y antiolor.
- ▶ Ideal para su uso en lugares públicos y zonas comunes.



Referencia	Color	U. / Caja
PC018ABG1	Blanco / Gris	1

- 180 mm
- 570 mm
- 360 mm

Lux

Compresero con tapa balancín en acero inoxidable Aisi 304. 40L.

- ▶ Fabricada en acero inoxidable AISI 304./ Chapa electrocincada con acabado pintado.
- ▶ Cabezal y balancín fabricados en acero.
- ▶ Fácil mantenimiento.
- ▶ Ideal para su uso en aseos públicos.



Referencia	Color	U. / Caja
PC021AIS1	Satinado	1
PC022ACW1	Blanco	1

- 320 mm
- 650 mm
- 200 mm

Referencia	Capacidad	Color	Medida  	U. / Caja
PP101AIS1	3L	Satinado	250 X 168 mm	6
PP101AIB1		Brillo		
PP001ACW1		Blanco		
PP101ACN1		Negro 		
PP102AIS1	5L	Satinado	272 X 203 mm	6
PP102AIB1		Brillo		
PP002ACW1		Blanco		
PP102ACN1		Negro		
PP104AIS1	12L	Satinado	392 X 249 mm	4
PP104AIB1		Brillo		
PP004ACW1		Blanco		
PP104ACN1		Negro		
PP106AIS1	20L	Satinado	445 X 290 mm	2
PP106AIB1		Brillo		
PP107AIS1	30L	Satinado	645 X 290 mm	1
PP107AIB1		Brillo		



IDÓNEO PARA HOSPITAL/QUIRÓFANO

Urania

Papelera con pedal en ABS

- ▶ Accionamiento mediante pedal
- ▶ Resistente y duradera
- ▶ Apropiaada para espacios públicos y colectividades.
- ▶ Especialmente indicada para hospitales.



Referencia	Capacidad	Color	U. / Caja
PI502ABG1	30L	Gris	5
PI503ABG1	68L	Gris	3
HOSPITAL - PI502ABA1	30L	Amarillo	5
HOSPITAL - PI503ABA1	68L	Amarillo	3



Aria

Papelera con pedal en polipropileno

- ▶ Accionamiento mediante pedal
- ▶ Fácil de limpiar
- ▶ Apropiaada para espacios públicos y colectividad

Referencia	Capacidad	Color	U. / Caja
PI509ABG1	25L	Gris	4



Soft 12

Papelera 12L

- ▶ Papelera de cierre amortiguado
- ▶ Fabricada en Acero Inoxidable.
- ▶ Apertura higienica con pedal
- ▶ Facil mantenimiento



Referencia	Capacidad	Color	U. / Caja
PP105AIS1	12L	Satinado	2
PP105ACN1	12L	Negro	2



Soft 30

Papelera 30L

- ▶ Papelera de cierre amortiguado
- ▶ Fabricada en Acero Inoxidable.
- ▶ Apertura higienica con pedal
- ▶ Facil mantenimiento



Referencia	Capacidad	Color	U. / Caja
PP147AIS1	30L	Negro	1
PP147ACN1	30L	Satinado	1



Soft 6

Papelera cuadrada con cierre suave 6L

- ▶ Papelera de cierre amortiguado
- ▶ Fabricada en Acero Inoxidable.
- ▶ Apertura higienica con pedal
- ▶ Facil mantenimiento



Satinado



Negro

Referencia	Capacidad	Color	U. / Caja
PP103AIS1	6L	Satinado	6
PP103ACN1	6L	Negro	6







Temis

Papelera basculante en acero inoxidable Brillo

- ▶ Fabricada en acero inoxidable.
- ▶ Apropia para espacios públicos y colectividades.
- ▶ Cubeta de plástico interior.

Referencia	Capacidad	Medidas  	Color	U. / Caja
PI101AIB1	10L	415 mm x 205 mm	Brillo	4
PI100AIB1	35L	660 mm x 300 mm	Brillo	1

Gaia

NUEVO

Papelera basculante en polipropileno Blanco.

- ▶ Tapa tipo balancín.
- ▶ Ideal para reciclaje.
- ▶ Fácil de limpiar.
- ▶ Apropia para espacios públicos y colectividades.

Referencia	Capacidad	Color Tapa	U. / Caja
PI105ABW0	10L	Blanca	20
PI103ABW0	25L	Blanca	10
PI103ABA0	25L	Amarillo	10
PI103ABG0	25L	Gris	10
PI103ABV0	25L	Verde	10
PI103ABZ0	25L	Azul	10
PI104ABW0	50L	Blanca	5
PI104ABA0	50L	Amarillo	5
PI104ABG0	50L	Gris	5
PI104ABV0	50L	Verde	5
PI104ABZ0	50L	Azul	5



Colores Tapa



10L   
245 mm 378 mm 212 mm

25L   
315 mm 530 mm 274 mm

50L   
360 mm 610 mm 314 mm



Delia

Papelera basculante en ABS con tapa en color negro

- ▶ Accionamiento mediante push.
- ▶ Resistente y duradera.
- ▶ Apropia para espacios públicos y colectividades.

Referencia	Capacidad	Color	U. / Caja
PI110ABG1	25L	Gris	20
PI111ABG1	40L	Gris	10
PI112ABG1	60L	Gris	5

25L   
330 mm 440 mm 270 mm

40L   
390 mm 610 mm 310 mm

60L   
390 mm 700 mm 400 mm





Hera

Papelera basculante

- ▶ Fabricada en Acero inoxidable Aisi 304 / Acero acabado pintado.
- ▶ Apropia para espacios públicos y colectividades.
- ▶ Resistente a la corrosión.

Referencia	Capacidad	Color	U. / Caja
PI107AIB1	80L	Satinado	1
PI108ACW1	80L	Blanco	1

 250 mm
 950 mm
 320 mm





Eris

Papelera basculante en ABS con tapa en color gris

- ▶ Fácil de limpiar.
- ▶ Resistente y duradera.
- ▶ Apropia para espacios públicos y colectividades.

Referencia	Capacidad	Color	U. / Caja
PI109POG1	60L	Gris	4



 340 mm
 790 mm
 450 mm





Color personalizable

Selena

Papelera basculante

- ▶ Fabricada en Acero inoxidable Aisi 304 / Chapa electro cincada con acabado pintado.
- ▶ Incluye gancho interior para la bolsa.
- ▶ Apropia para espacios públicos y colectividades.

Referencia	Capacidad	Color	U. / Caja
PI102AIS0	40L	Satinado	1
PI102ACW0	40L	Blanco	1

 320 mm
 680 mm
 260 mm



Carla

Papelera 12L.

- ▶ Fabricada en Acero inoxidable.
- ▶ Recomendada para oficinas y espacios de interior.
- ▶ Resistente y duradera.
- ▶ Fácil de limpiar.

Referencia	Capacidad	Color	U. / Caja
PI427AIS1	12L	Satinada	1
PI427ACN1	12L	Negro	1

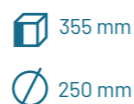

Cuprum

Papelera 6L.

- ▶ Papelera de elegante diseño para espacios interiores.
- ▶ Fácil mantenimiento.
- ▶ Cubo extraíble de fácil limpieza.

Referencia	Capacidad	Color	U. / Caja
PI426ACN1	6L	Negro	6
PI426ACT1	6L	Tungsteno	6



Brezo

Papelera 10L.

- ▶ Fabricada en Acero inoxidable / Chapa electro cincada con acabado pintado.
- ▶ Recomendada para oficinas y espacios de interior.
- ▶ Fabricada en acero inoxidable.
- ▶ Resistente y duradera.

Referencia	Capacidad	Color	U. / Caja
PI401AIS0	10L	Satinado	1
PI401ACW0	10L	Blanco	1
PI401ACN0	10L	Negro	1

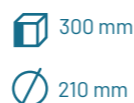

Idalia

Papelera con tapa balancín en acero inoxidable Satinado

- ▶ Fabricada en acero inoxidable.
- ▶ Accionamiento mediante tapa balancín.
- ▶ Doble cuerpo y base de goma protectora.

Referencia	Capacidad	Color	U. / Caja
PI116AIS1	10L	Satinado	6
PI118AIS1	40L	Satinado	2

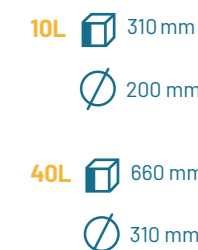

Polipiel

Papelera de doble cuerpo en acero y forrada en polipiel con borde superior de plata

- ▶ Fabricada en acero.
- ▶ Resistente y duradera.
- ▶ Doble cuerpo.

Referencia	Capacidad	Color	U. / Caja
PI412SDN1	10L	Polipiel Negro	6
PI411SDI1	10L	Polipiel Marrón	6

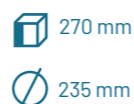

Clavel

Papelera de doble cuerpo en acero Negro con borde superior de plata

- ▶ Fabricada en acero.
- ▶ Resistente y duradera.
- ▶ Doble cuerpo.

Referencia	Capacidad	Color	U. / Caja
PI410SDI1	10L	Negro/Plata	6

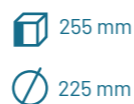

Garbera

Papelera de pared o suelo en acero inoxidable Aisi 304

- ▶ Recomendada para oficina y espacios de interior.
- ▶ Fabricada en acero AISI 304.

Referencia	Capacidad	Color	U. / Caja
PI405AIS0	10L	Satinado	1
PI405AIB0	10L	Brillo	1



Feria

Papelera en polipropileno

- ▶ Recomendada para oficinas y espacios de interior.
- ▶ Fácil de limpiar.
- ▶ Fabricada en polipropileno resistente y duradero.

Referencia	Capacidad	Color	U. / Caja
PI402ABN1	14L	Negro	20
PI402ABE1	14L	Beige	20



Girasol

Papelera en acero inoxidable Aisi 304 Satinado

- ▶ Recomendada para oficina y espacios de interior.
- ▶ Fabricada en acero AISI 304.

Referencia	Capacidad	Color	U. / Caja
PI403AIS0	25L	Satinado	1
PI403AIB0	25L	Brillo	1





Jazmín

Papelera con o sin cenicero.
En Acero Inoxidable / Chapa electrocincada con acabado pintado

- ▶ Recomendada para grandes superficies.
- ▶ Fabricada en acero resistente a la oxidación.
- ▶ Incluye cenicero.

Referencia	Capacidad	Color	U. / Caja
Sin Cenicero - PI304AIS1	40L	Satinado	1
Con Cenicero - PI301AIS1	40L	Satinado	1
Con Cenicero - PI301ACW1	40L	Blanco	1

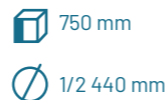

Lirio

Papelera con cenicero en Acero Inoxidable

- ▶ Recomendada para despachos y oficinas.
- ▶ Fabricada en acero resistente a la oxidación.
- ▶ Incluye cenicero.

Referencia	Capacidad	Color	U. / Caja
PI219AIB1	12L	Brillo	1
PI219ACN1	12L	Negro	1
PI219ACW1	12L	Blanca	1

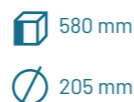

Violeta

Papelera con cenicero en Acero Inoxidable

- ▶ Recomendada para despachos y oficinas.
- ▶ Fabricada en acero.
- ▶ Incluye cenicero.

Referencia	Capacidad	Color	Cenicero	U. / Caja
PI220AIS0	13L	Satinado	Satinado	1
PI220ACN0	13L	Negro	Blanco	1

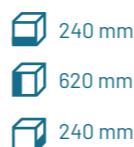

Color personalizable

Rosa

Papelera con cenicero en chapa electrocincada con acabado pintado

- ▶ Recomendada para despachos y oficinas.
- ▶ Fabricada en acero.
- ▶ Incluye cenicero.

Referencia	Capacidad	Color	U. / Caja
PI210ACW0	20L	Blanco	1
PI210ACN0	20L	Negro	1

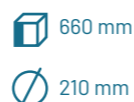

Pera

Papelera con cenicero en plancha aluzinc

- ▶ Recomendada para despachos y oficinas.
- ▶ Fabricada en acero.
- ▶ Incluye cenicero.

Referencia	Capacidad	Color	U. / Caja
PI217ACW0	15L	Blanco	1
PI217ACN0	15L	Negro	1



Jara

Papelera con cenicero en plancha aluzinc

- ▶ Recomendada para despachos y oficinas.
- ▶ Fabricada en acero.
- ▶ Incluye cenicero.

Referencia	Capacidad	Color	U. / Caja
PI211AIB1	15L	Brillo	1

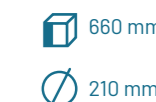

Ingenio

Papelera con cenicero en Acero Inoxidable AISI 304 / Chapa electrocincada con acabado pintado

- ▶ Recomendada para despachos y oficinas.
- ▶ Fabricada en acero.
- ▶ Incluye cenicero.

Referencia	Capacidad	Color	U. / Caja
PI209AIS0	15L	Satinado	1
PI208ACW0	15L	Blanco	1

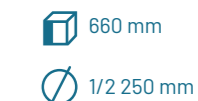

Verdel

Papelera con cenicero en Acero Inoxidable / Chapa electrocincada con acabado pintado

- ▶ Recomendada para despachos y oficinas.
- ▶ Fabricada en acero.
- ▶ Incluye cenicero.

Referencia	Capacidad	Color	U. / Caja
PI215AIS0	30L	Satinado	1
PI215ACW0	30L	Blanco	1

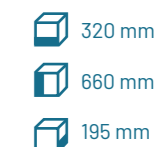

Lisa

Papelera con cenicero en acero.

- ▶ Tapa fabricada en acero inoxidable AISI 304 y el cuerpo en metal.
- ▶ Apropriada para espacios públicos y colectividades.
- ▶ Resistente a la corrosión.

Referencia	Capacidad	Color	U. / Caja
PI106AIW1	80L	Acero/Blanco	1

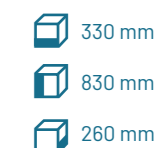



NUEVO

Trineo

Papelera de selección, cuerpo en acero 0,6mm

- ▶ Recomendada para oficinas y espacios interiores.
- ▶ Resistente y duradera.
- ▶ Ideal para la clasificación y reciclaje de residuos

Referencia	Capacidad	Color	U. / Caja
PI418SDI1	3x3,5L	Negro	1

- 280mm
- 308mm
- 280mm



Color personalizable

Oceanía

Papelera de clasificación en acero inoxidable AISI 304
Papelera de clasificación en chapa electrocincada pintada

- ▶ Recomendada para grandes superficies.
- ▶ Gran resistencia a los golpes y abolladuras.
- ▶ Ideal para la clasificación y reciclaje de residuos.

Referencia	Capacidad	Color	U. / Caja
PI303AIS1	3x28L	Satinado	1
PI303ACI1	3x28L	Chapa Pintada	1

- 620 mm
- 710 mm
- 210 mm



Color personalizable

Nova

Papelera de clasificación con aro sujeta bolsas en chapa electrocincada pintada

- ▶ Recomendada para grandes superficies.
- ▶ Gran resistencia a los golpes y abolladuras.
- ▶ Ideal para la clasificación y reciclaje de residuos.

Referencia	Capacidad	Color	U. / Caja
PI310ACI1	3x35L	Chapa Pintada	1

- 500 mm
- 840 mm
- 300 mm



Color personalizable

Néctar

Papelera de clasificación en acero inoxidable Aisi 304

- ▶ Recomendada para grandes superficies.
- ▶ Gran resistencia a los golpes y abolladuras.
- ▶ Ideal para la clasificación y reciclaje de residuos

Referencia	Capacidad	Color	U. / Caja
PI308AIS1	3x42L	Satinado	1
PI308ACI1	3x42L	Pintado	1

- 800 mm
- 490 mm



Blume

NUEVO

Papelera de clasificación en polipropileno con cuerpo en Gris. 50l. Posibilidad de unirse a otra unidad del Modelo Blume.

- ▶ Sistema modular mediante anclaje laterales.
- ▶ Configuración personalizable.
- ▶ Aro sujeta bolsas.
- ▶ Ideal para la clasificación y reciclaje de residuos.



- 397 mm
- 620 mm
- 335 mm

	Referencia	Capacidad	Color TAPA	U. / Caja
●	C0374POA4	50L	Amarillo	1
●	C0374POR4	50L	Rojo	1
●	C0374POV4	50L	Verde	1
●	C0374POZ4	50L	Azul	1



Color cabezal personalizable

Lumen

Papelera de clasificación con aro sujeta bolsas en chapa electrocincada color Negro y con tapa de color reciclaje

- ▶ Recomendada para grandes superficies.
- ▶ Gran resistencia a los golpes y abolladuras.
- ▶ Cabezal con colores personalizables.

Referencia	Capacidad	Color	U. / Caja
PI309ACI1	80L	Negro	1

- 510 mm/ unidad
- 840 mm/ unidad
- 270 mm/ unidad



Transit

Papelera de clasificación con aro sujeta bolsas en chapa electrocincada color Plata y con tapa de color reciclaje

- ▶ Recomendada para grandes superficies.
- ▶ Gran resistencia a los golpes y abolladuras.
- ▶ Aro interior sujeta bolsas.
- ▶ Color de la boca personalizable.

Referencia	Capacidad	Color	U. / Caja
PI306ACI1	70L	Plata	1

- 350 mm/unidad
- 800 mm/unidad
- 250 mm/unidad



Color cabezal personalizable



Transit Aero

Papelera de clasificación con aro sujeta bolsas y ventana frontal y trasera transparente (modelo seguridad aero-portuaria) en chapa electrocincada color Plata y con tapa de color reciclaje

- ▶ Recomendada para grandes superficies.
- ▶ Gran resistencia a los golpes y abolladuras.
- ▶ Aro interior sujeta bolsas.
- ▶ Color de la boca personalizable.

Referencia	Capacidad	Color	U. / Caja
PI311ACI1	70L	Plata	1

- 365 mm/unidad
- 700 mm/unidad
- 275 mm/unidad



Color cabezal personalizable



Narciso

Papelera con boca superior abierta

- ▶ Acero galvanizado exterior
- ▶ Parte superior que se puede retirar del cuerpo
- ▶ Parte inferior con anillo de goma
- ▶ Recomendada para grandes superficies
- ▶ Gran resistencia a los golpes y abolladuras

Referencia	Capacidad	Color	U. / Caja
PI316ACN0	55L	Negro	1

- 247 mm
- 813 mm
- 229 mm



Orquídea

Papelera de clasificación con tapa color

- ▶ Acero galvanizado exterior e interior
- ▶ El cuerpo y la tapa se conectan con bisagra para facilitar la limpieza
- ▶ Zócalo inferior perforado
- ▶ Recomendada para grandes superficies
- ▶ Gran resistencia a los golpes y abolladuras

Referencia	Capacidad	Color	U. / Caja
PI317ACV0	36L	Verde	1
PI317ACZ0	36L	Azul	1
PI317ACY0	36L	Amarillo	1
PI317ACG0	36L	Gris	1



- 300 mm
- 765 mm
- 300 mm



Magnolia

Papelera de clasificación con tapa color

- ▶ Acero galvanizado exterior e interior
- ▶ La parte superior se retira del cuerpo para realizar la limpieza
- ▶ Serigrafía del logo de reciclaje
- ▶ Recomendada para grandes superficies
- ▶ Gran resistencia a los golpes y abolladuras

Referencia	Capacidad	Color	U. / Caja
PI318ACV0	23L	Verde	1
PI318ACZ0	23L	Azul	1
PI318ACY0	23L	Amarillo	1
PI318ACG0	23L	Gris	1



- 245 mm
- 630 mm
- 245 mm



Vórtice

Papelera con tres bocas para clasificación

- ▶ Acero galvanizado exterior y tapa acero inoxidable cepillado
- ▶ Parte superior que se puede retirar del cuerpo
- ▶ Parte inferior con anillo de goma
- ▶ Recomendada para grandes superficies
- ▶ Gran resistencia a los golpes y abolladuras

Referencia	Capacidad	Color	U. / Caja
PI319ACN0	60L	Negro	1

- 550 mm
- 800 mm
- 540 mm



Orígenes

Papelera con tres bocas para clasificación

- ▶ Acero galvanizado exterior e interior
- ▶ El cuerpo y la tapa se conectan con bisagra para facilitar la limpieza
- ▶ Zócalo inferior perforado
- ▶ Recomendada para grandes superficies
- ▶ Gran resistencia a los golpes y abolladuras

Referencia	Capacidad	Color	U. / Caja
PI320ACN0	112.5L	Negro	1



- 830 mm
- 760 mm
- 300 mm

Stickers para la personalización de la clasificación



Panacea

Papelera exterior con pie a suelo en acero perforado

- ▶ Fácil vaciado mediante sistema abatible.
- ▶ Ideal para parques, jardines y zonas urbanas.
- ▶ Gran resistencia a los golpes y la oxidación.

885 mm

370 mm

Referencia	Capacidad	Color	U. / Caja
PE506ACG0	60L	Gris	1



Enigma

Papelera exterior con pie a suelo en acero inoxidable Aisi 304

- ▶ Acabado brillo elegante y funcional.
- ▶ Fácil vaciado mediante sistema abatible.
- ▶ Gran resistencia a los golpes y la oxidación.

885 mm

370 mm

Referencia	Capacidad	Color	U. / Caja
PE511AIB0	60L	Brillo	1



Arcadia

Papelera exterior a pared en acero perforado

- ▶ Diseño mural.
- ▶ Fácil vaciado mediante sistema abatible.
- ▶ Gran resistencia a los golpes y a la oxidación.

540 mm

1/2 480 mm

Referencia	Capacidad	Color	U. / Caja
PE508AC00	35L	Gris	1



Artist

Papelera exterior artística con pie a suelo en acero

- ▶ Diseño elegante.
- ▶ Fácil vaciado.
- ▶ Gran resistencia a los golpes y a la oxidación.

1,470 mm

323 mm

Referencia	Capacidad	Color	U. / Caja
PE509AC00	35L	Gris	1



Madelux 500 / 501

Papelera exterior con pie a suelo en madera con estructura de acero y cubeta interior de acero galvanizado

- ▶ Construida con madera hardwood.
- ▶ Ideal para jardines y zonas urbanas.
- ▶ Cubeta interior de acero galvanizado.

Referencia	Capacidad	Color	U. / Caja
PE500MAI0	40L	Madera	1
PE501MAI0	40L	Madera	1

700 mm

450 mm

780 mm

395 mm



Madelux 502 / 503

Papelera exterior a suelo con cenicero en madera con estructura de acero y cubeta interior de acero galvanizado

- ▶ Construida con madera hardwood.
- ▶ Ideal para jardines y zonas urbanas.
- ▶ Cubeta interior de acero galvanizado.

Referencia	Capacidad	Color	U. / Caja
PE502MAI0	40L	Madera	1
PE503MAI0	25L	Madera	1

700 mm

395 mm

365 mm

820 mm

365 mm



Malaguita

Papelera exterior para poste/farola en polietileno de alta densidad Verde.

- ▶ Construida en HDPE con tratamiento anti UVA.
- ▶ Ideal para jardines y zonas urbanas.
- ▶ Fácil vaciado.
- ▶ Apropiaada para su colocación en poste o farola.

Referencia	Capacidad	Color	U. / Caja
PE504POV4	50L	Verde	1

430 mm

760 mm

340 mm



Vespa



Papelera de parking para pared en acero inoxidable AISI 304 / Chapa electrocincada acabado pintado

- ▶ Fabricada en acero AISI 304.
- ▶ Gran resistencia a los golpes y abolladuras.
- ▶ Tamaño contenido pero funcional.

Referencia	Capacidad	Color	U. / Caja
PE100AIS0	10L	Satinado	1
PE100ACW0	10L	Blanco	1



Cenicero adaptable

Cenicero adaptable para cualquier papelera de exterior en acero inoxidable

- ▶ Fácil vaciado.
- ▶ Gran resistencia a los golpes y la oxidación.
- ▶ Acoplable a la mayoría de papeleras de exterior.

Referencia	Color	U. / Caja
PE512AIB1	Brillo	1



Glacial



Papelera de parking para pared con cenicero / Chapa electrocincada acabado pintado

- ▶ Fabricada en acero.
- ▶ Gran resistencia a los golpes y abolladuras.
- ▶ Tamaño contenido pero funcional.

Referencia	Capacidad	Color	U. / Caja
PE101ACV0	15L	Verde	1

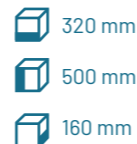

Irisa

Cenicero a pared de aluminio y tapa en acero inoxidable

- ▶ Diseño mural.
- ▶ Gran resistencia a la oxidación.

Referencia	Color	U. / Caja
AH801AII1	Satinado	1

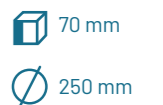

Solara



Papelera de parking para pared / Chapa electrocincada acabado pintado

- ▶ Fabricada en acero.
- ▶ Ideal para parkings, cajeros y jardines.
- ▶ Gran resistencia a los golpes y abolladuras.

Referencia	Capacidad	Medidas	Color	U. / Caja
Pared - PE103ACW0	20L	360 x 430 x 250 mm	Blanco	1
Suelo - PE105ACW0	20L	360 x 1000 x 250 mm	Blanco	1



Edenia

Cenicero basculante a pared en acero inoxidable

- ▶ Diseño mural basculante.
- ▶ Fácil vaciado
- ▶ Gran resistencia a la oxidación.

Referencia	Color	U. / Caja
AH800AII1	Brillo	1



Amore



Papelera de parking para pared con cenicero / Chapa electrocincada acabado pintado

- ▶ Fabricada en acero.
- ▶ Ideal para parkings, cajeros y jardines.
- ▶ Gran resistencia a los golpes y abolladuras.

Referencia	Capacidad	Medidas	Color	U. / Caja
Pared - PE104ACW0	20L	360 x 540 x 250 mm	Blanco	1
Suelo - PE106ACW0	20L	360 x 1000 x 250 mm	Blanco	1



Elara

Cenicero basculante a pared en chapa electrocincada de color a elegir

- ▶ Diseño mural basculante.
- ▶ Fácil vaciado.
- ▶ Gran resistencia a la oxidación.

Referencia	Color	U. / Caja
AH802ACZ0	Azul	20



Orenda



Papelera de parking para pared en acero inoxidable

- ▶ Fabricada en acero.
- ▶ Ideal para parkings, cajeros y jardines.
- ▶ Gran resistencia a los golpes y abolladuras.

Referencia	Capacidad	Color	U. / Caja
PE102AIS0	25L	Satinado	1
PE102AIB0	25L	Brillo	1



Urbano

Cenicero urbano a pared con cerradura de acceso en chapa electrocincada con pintado Oxiron y embellecedor en acero inoxidable Aisi 304.

- ▶ Diseño mural de gran capacidad.
- ▶ Chapa de 1,2 mm de gran resistencia a los golpes.
- ▶ Fácil vaciado.
- ▶ Gran resistencia a la oxidación.

Referencia	Medidas	Color	U. / Caja
Pared - AH804AC00	200 x 315 x 150 mm	Oxiron	1
Suelo - AH803AC00	200 x 880 x 150 mm	Oxiron	1



Ver
productos



Contenedores

Los contenedores de basura de plástico ofrecen numerosos beneficios. Son duraderos y resistentes, evitando la oxidación y astillamiento. Además, su peso ligero permite una mayor conveniencia al vaciarlos. Son fáciles de limpiar y mantener en buen estado, siendo versátiles en colores y diseños.

Son muy importantes para mantener espacios limpios y promover la conciencia ambiental, facilitando el reciclaje y la mejora en la gestión de residuos. Son adaptables, duraderos, asequibles y reciclables. En Jami Brisass encontrarás diversas opciones aptas para diferentes lugares e instalaciones, incluyendo una variedad de capacidades y características especiales.





Lila

Contenedor con pedal o sin pedal de polipropileno 120L

- ▶ Tapa con apertura auxiliar para mayor comodidad.
- ▶ Apertura mediante pedal de acero.
- ▶ Ruedas de alta resistencia para su transporte.



	Referencia	Capacidad	Color	U. / Caja
●	Con Pedal - C0361POV4	120L	Verde	4
●	Con Pedal - C0361POG4	120L	Gris	4
●	Con Pedal - C0361POA4	120L	Amarillo	4
●	Con Pedal - C0361POZ4	120L	Azul	4
●	Sin Pedal - C0360POV4	120L	Verde	4
●	Sin Pedal - C0360POG4	120L	Gris	4
●	Sin Pedal - C0360POA4	120L	Amarillo	4
●	Sin Pedal - C0360POZ4	120L	Azul	4

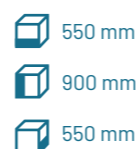

Luxor

Contenedor sin pedal de polietileno de alta densidad HDPE-EN840

- ▶ Fabricado en HDPE de alta resistencia.
- ▶ Ruedas de alta resistencia para su transporte.
- ▶ Fácil de maniobrar gracias a su base con ruedas giratorias.
- ▶ Indicado para la gestión de residuos.

	Referencia	Capacidad	Color	U. / Caja
●	C0351POA4	120L	Amarillo	1
●	C0351POR4	120L	Rojo	1
●	C0351POV4	120L	Verde	1
●	C0351POZ4	120L	Azul	1
●	C0351POM4	120L	Marrón	1
●	C0351POG4	120L	Gris	1
●	C0352POA4	240L	Amarillo	1
●	C0352POR4	240L	Rojo	1
●	C0352POV4	240L	Verde	1
●	C0352POZ4	240L	Azul	1



Pedal para contenedor Luxor
120L - RP351PED1
120L/240L - RP351UNI1



Orendi

Contenedor con pedal de polipropileno Gris y tapa en color

- ▶ Apertura con pedal.
- ▶ Ruedas para facilitar su transporte.
- ▶ Apropiado para colectividades y espacios públicos.



	Referencia	Capacidad	Color Tapa	U. / Caja
	C0373SDA4	70L	Amarillo	1
	C0373SDR4	70L	Rojo	1
	C0373SDV4	70L	Verde	1
	C0373SDZ4	70L	Azul	1



Neoma

Contenedor con pedal de polipropileno Verde

- ▶ Apertura con pedal.
- ▶ Ruedas para facilitar su transporte.
- ▶ Especialmente indicado para el canal HORECA.



	Referencia	Capacidad	Color	U. / Caja
	C0357POV4	70L	Verde	1



Biger

Contenedor sin pedal de polietileno de alta densidad HDPE-EN840 Verde

- ▶ Fabricado en HDPE de alta resistencia.
- ▶ Ruedas de caucho anti suciedad. 2 de ellas con freno incorporado.
- ▶ Disponible en varios colores bajo pedido.
- ▶ Indicado para la gestión de residuos urbanos.
- ▶ Tratamiento anti UV.

	Referencia	Capacidad	Medidas	Color	U. / Caja
	C0354POV1	800L	1.365 x 1.373 x 776 mm	Verde	1
	C0353POV1	1.100L	1.370 x 1.354 x 1.073 mm	Verde	1



Nocturna

Contenedor con pedal de polipropileno Verde de 120L

- ▶ Apertura mediante pedal de acero.
- ▶ Ruedas de alta resistencia para su transporte.
- ▶ Apropiado para gestión de residuos.



	Referencia	Capacidad	Color	U. / Caja
	C0362POV4	120L	Verde	1

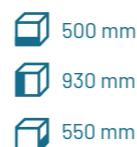

Circus

Contenedor de base rodante sin pedal de polipropileno

- ▶ Fabricado en HDPE de alta resistencia.
- ▶ Ruedas de alta resistencia para su transporte.
- ▶ Fácil de maniobrar gracias a su base con ruedas giratorias.

	Referencia	Capacidad	Color	U. / Caja
	C0350POG4	120L	Gris	1

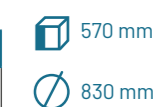



Ver
productos



Dispensadores de Aerosoles. Exterminadores.

Los insectos no deseados, como moscas, mosquitos y polillas, pueden ser una molestia en diversos entornos, desde hogares y oficinas hasta restaurantes y áreas comerciales. Para controlar y eliminar eficazmente estos insectos, se utilizan los exterminadores de insectos, también conocidos como lámparas o trampas para insectos.

Por otro lado, los olores que se pueden generar en tu negocio tienen un efecto directo en el bienestar de las personas trabajadoras y clientes. Además, el aroma que se respira al entrar influye a la hora de crear una imagen de marca de tu negocio. Los sistemas de ambientación automáticos son la solución óptima para aromatizar tu negocio de forma permanente.





Dispensador aerosoles Bruma

Dispensador automático de aerosoles ambientadores o insecticidas para carga de 250ml

- 90 mm
- 248 mm
- 83 mm

- ▶ Intervalos de pulverización variables.
- ▶ Control continuo de insectos.
- ▶ Apto para colectividades.

Referencia	Color	U. / Caja
DA932ABW0	Blanco	15



Aerosol Insecticida

Aerosol Insecticida con piretrina natural de 250ml. Uso exclusivo para dispensador automático.

- ▶ Eficaz contra insectos voladores y rastreros.
- ▶ Insecticida superconcentrado.

Aerosol	Referencia	Capacidad	U. / Caja
Piretrina Natural	RI906PNI1	250ml	8
Piretrina Sintética	RI993PSI1	250ml	6



Aerosol Ambientador

Aerosol Ambientador de 250ml. Uso exclusivo para dispensador automático.

- ▶ Aroma agradable y persistente.
- ▶ Apto para dispensador de aerosol automático.

Aerosol	Referencia	Capacidad	U. / Caja
Eternity	RA990SDI1	250ml	6
C.K.	RA991SDI1	250ml	6



Exterminador LED-Plus

Exterminador eléctrico de insecto en aluminio de 2x6,5w

- ▶ Lámpara de LED de 6,5 W.
- ▶ Fabricado en Aluminio resistente a la corrosión.
- ▶ Bandeja extraíble. Cobertura 40/90 m2

Referencia	Color	U. / Caja
EX419ALLO	Brillo	2
EX420ALLO	Negro	2

RP419ALL1/420ALL1	Recambio Lámpara 6,5 W / 7W
-------------------	-----------------------------

EX419ALLO

 540 mm 270 mm 80 mm

EX420ALLO

 380 mm 264 mm 80 mm

Exterminador Elektra

Exterminador eléctrico de insectos en aluminio de 2x6W

- ▶ Fabricado en aluminio resistente a la corrosión.
- ▶ Bandeja extraíble.
- ▶ Cobertura: 30 m2.

Referencia	Potencia consumida	U. / Caja
EX412ALS0	2x6W	8

RP412SDI1	Recambio Tubo 6W
-----------	------------------

- 486 mm
- 264 mm
- 72 mm



Exterminador Vera

Exterminador eléctrico con adhesivo para insectos en ABS Blanco de 2x18W

- ▶ Fabricado en ABS ignífugo.
- ▶ Apertura de ventana a 90º para una fácil manipulación.
- ▶ Tubo UV-A diseñado para una máxima atracción.
- ▶ Cobertura: 80 m2.

Referencia	Potencia consumida	U. / Caja
EX418ABW0	2x18W	2

RP418ADI1	Recambio Adhesivo
RP418SDI1	Recambio Tubo

- 486 mm
- 264 mm
- 72 mm



Ver
productos



Taquillas y Bancos de Vestuario

Maximizar el espacio disponible es fundamental para cualquier empresa o instalación que necesita disponer de dispositivos para sus clientes, usuarios o trabajadores en los que depositar efectos personales. La instalación de taquillas y armarios se ha convertido en una necesidad y una solución redonda para estos casos.





Victoria

Taquillas, techo y bastidor en chapa galvanizada Gris claro. Fabricación bajo pedido

- ▶ Fabricada en acero.
- ▶ Conforme a la norma UNE-EN 1473 / UNE-EN 16121.
- ▶ Disponible en RAL 7024, 9006, 7035, 5010 sin coste adicional.
- ▶ Incluye barra porta perchas. (menos en taquilla 4 puertas)
- ▶ Incluye llave y cerradura de seguridad.

Referencia	Modelo	Medidas 	U. / Caja
TQ027MEG1	Taquilla 1 puerta 1 columna	1.800mm x 470mm x 300mm	1
TQ028MEG1	Taquilla 2 puertas 2 columnas	1.800mm x 470mm x 580mm	1
TQ029MEG1	Taquilla 3 puerta 3 columnas	1.800mm x 470mm x 850mm	1
TQ030MEG1	Taquilla 2 puertas 1 columna	1.800mm x 470mm x 300mm	1
TQ031MEG1	Taquilla 4 puertas 2 columnas	1.800mm x 470mm x 580mm	1
TQ032MEG1	Taquilla 6 puertas 3 columnas	1.800mm x 470mm x 850mm	1
TQ033MEG1	Taquilla 12 puertas 3 columnas	850mm x 1.800mm x 470mm	1
TQ036MEG1	Techo sanitario taquilla 1 columna	500mm x 300mm	1
TQ037MEG1	Techo sanitario taquilla 2 columnas	500mm x 580mm	1
TQ038MEG1	Techo sanitario taquilla 3 columnas	500mm x 850mm	1
TQ039MEG1	Bastidor de patas para taquillas	90mm (altura)	1



Aurora Montaje sin tornillos

Taquillas, techo y pata en chapa galvanizada gris claro con puerta azul

- ▶ Fabricada en acero.
- ▶ Ahorre en costes de montaje gracias a nuestro sistema de anclaje sin tornillos.
- ▶ Incluye barra porta perchas.
- ▶ Incluye llave y cerradura de seguridad.

Referencia	Modelo	Medidas 	U. / Caja
TQ040MEZO	Taquilla inicial 1 puerta 1 columna	1.800mm x 500mm x 300mm	1
TQ041MEZO	Taquilla extensión 1 puerta 1 columna	1.800mm x 500mm x 300mm	1
TQ042MEZO	Taquilla inicial 2 puertas 1 columna	1.800mm x 500mm x 300mm	1
TQ043MEZO	Taquilla extensión 2 puerta 1 columna	1.800mm x 500mm x 300mm	1
TQ051SDI1	Techo sanitario taquilla inicial	150mm x 500mm x 300mm	1
TQ052SDI1	Techo sanitario taquilla inicial + extensión	150mm x 500mm x 600mm	1
TQ053SDI1	Techo sanitario taquilla inicial + 2 extensiones	150mm x 500mm x 900mm	1
TQ049SDI1	Pata para taquilla inicial	100mm x 60mm x 60mm	1
TQ050SDI1	Pata para taquilla extensión	100mm x 60mm x 120mm	1



Artea

Taquillas en chapa galvanizada gris claro.

- ▶ Fabricada en acero.
- ▶ Montaje sin tornillos. Ahorre en costes de montaje gracias a nuestro sistema de anclaje sin tornillos.
- ▶ Incluye llave y cerradura de seguridad.

NUEVO

Referencia	Modelo	Medidas 	U. / Caja
TQ044MEGO	Taquilla inicial 1 columna 4 puertas	1.800mm x 500mm x 300mm	1
TQ045MEGO	Taquilla extensión 1 columna 4 puertas	1.800mm x 500mm x 300mm	1



-  1.000 mm
-  480 mm
-  325 mm



-  2.000 mm
-  480 mm
-  325 mm

Oasis

Banco de vestuario simple o doble

- ▶ Fabricado en acero.
- ▶ Especialmente indicado para vestuarios.
- ▶ Listones de pino barnizados.

Referencia	Color	U. / Caja
Simple - BV102MAI1	Madera de pino barnizado.	1
Doble - BV202MAI1	Madera de pino barnizado.	1



Ver
productos



Carros de Limpieza y Servicio

Los carros de limpieza y servicio han ido adentrándose poco a poco en el mercado de la limpieza e higiene profesional hasta convertirse en una herramienta de trabajo imprescindible para apartamentos turísticos, hoteles, restaurantes, gimnasios o colegios.





 510 mm
 1.135 mm
 980 mm

Fantasy

Carro limpieza simple con bolsa amarilla en polipropileno.

- ▶ Muy resistente gracias a su construcción en HDPE.
- ▶ Bandejas de diferente tamaño para colocar objetos.
- ▶ Bolsa amarilla de gran durabilidad.

Referencia	Color	U. / Caja
CR236POI4	Gris	1
CR201POI4	Azul	1

Recambio bolsa para carro

 RP236SDA4	1
 RP201SDA4	1



 650 mm
 870 mm
 400 mm

Pantera

Cubo escurridor con prensa y ruedas en polipropileno Gris y Amarillo de 32L

- ▶ Muy resistente gracias a su construcción en polipropileno.
- ▶ Buena maniobrabilidad gracias a sus 4 ruedas giratorias.

Referencia	U. / Caja
CR206POA4	1

Recambio de prensa para carro

 RP206POG4	2
---	---

Prensa diseñada para un uso intensivo.



 400 mm
 920 mm
 600 mm

Perla

Cubo escurridor con prensa y ruedas en polipropileno Amarillo de 32L

- ▶ Muy resistente gracias a su construcción en polipropileno.
- ▶ Buena maniobrabilidad gracias a sus 4 ruedas giratorias.

Referencia	U. / Caja
CR207POA4	1

Recambio

 RP207POA4	1
---	---

Prensa diseñada para un uso intensivo.



Glisten

Carro limpieza simple con bolsa amarilla en polipropileno Negro.

- ▶ Muy resistente gracias a su construcción en HDPE.
- ▶ Bandejas de diferente tamaño para colocar objetos.
- ▶ Bolsa amarilla con tapa para mantelería.

 550 mm
 1000 mm
 1300 mm

Referencia	U. / Caja
CR204PON4	1

Serena

Cubo escurridor con doble cubo con prensa y ruedas en polipropileno de 2x18L

- ▶ Gran resistencia y gran capacidad de carga.
- ▶ Mango tirador fabricado en acero.

Referencia	U. / Caja
CR202POG4	1

Recambio cubo Rojo 18L

 RP202POZ1	1 und.
---	--------

Recambio cubo Rojo 18L

 RP202POR1	1 und.
---	--------

RP206POG4
Prensa diseñada para un uso intensivo.



Glamur

Carro limpieza multifunción con bolsa amarilla en polipropileno Azul.

- ▶ Muy resistente gracias a su construcción en HDPE y su estructura tubular de acero.
- ▶ Bandejas de diferente tamaño para colocar objetos.
- ▶ Bolsa amarilla con tapa para mantelería.
- ▶ Incluye cubos.



 750 mm
 1100 mm
 1320 mm

Referencia	U. / Caja
CR203POI4	1

Recambios:

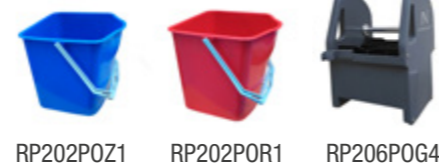

Ionic

Cubo escurridor con prensa y ruedas en polipropileno Azul de 20L

- ▶ Muy resistente gracias a su construcción en polipropileno.
- ▶ Buena maniobrabilidad gracias a sus 4 ruedas giratorias.

Referencia	U. / Caja
CR208POI4	1

Prensa diseñada para un uso intensivo.



 270 mm
 670 mm
 630 mm

Radiant

Cubo escurridor con prensa y ruedas en polipropileno Azul y Gris y estructura metálica con cesta de 23L

- ▶ Gran resistencia y gran capacidad de carga
- ▶ Mango tirador fabricado en acero.

Referencia	U. / Caja
CR205MEI4	1

RP206POG4
Prensa diseñada para un uso intensivo.



 400 mm
 940 mm
 560 mm

Señal de piso húmedo

Señal tipo carpa para piso húmedo color Amarillo.

- ▶ Diseñada para una gran visibilidad.
- ▶ Pensada para un uso intensivo.
- ▶ Advertencia por ambas caras y en varios idiomas.
- ▶ Personalizable bajo consulta de cantidad y disponibilidad.

Referencia	U. / Caja
SN423POA1	10

 300 mm
 570 mm
 400 mm





Vesper

Carro de lavandería con estructura metálica y bolsa color caqui o azul de 215L

- ▶ Gran resistencia gracias a su estructura de acero.
- ▶ Saco de gran capacidad.
- ▶ Buena maniobrabilidad gracias a sus 4 ruedas giratorias.



- 625 mm
- 985 mm
- 620 mm

Referencia	Color	U. / Caja
AH101MEZ4	Bolsa Azul	1
AH101MEI4	Bolsa Caqui	1



Recambio bolsa para carro

- ▶ Anclaje reforzado con enganches metálicos.

● RP101SDZ4	Bolsa Azul	1
● RP101SDI4	Bolsa Caqui	1



Camelia

Carro de lavandería con estructura metálica y bolsa color Caqui de 260L

- ▶ Gran resistencia gracias a su estructura de acero.
- ▶ Saco de gran capacidad.
- ▶ Buena maniobrabilidad gracias a sus 4 ruedas giratorias.

Referencia	Color	U. / Caja
AH100MEI4	Bolsa Caqui	1



- 545 mm
- 895 mm
- 940 mm

Recambio bolsa para carro

- ▶ Anclaje reforzado con enganches metálicos.

● RP100SDI4	Bolsa Caqui	1
-------------	-------------	---



- 540 mm
- 1200 mm
- 1500 mm

Crystal

Carro de transporte de lencería en polipropileno gris con dos bolsas color amarillo

- ▶ Fabricado en HDPE de gran resistencia.
- ▶ Doble bolsa de gran capacidad.
- ▶ Dispone de varias bandejas extraíbles y guiadas.

Referencia	U. / Caja
CR200POG1	1

Recambio bolsa para carro

● RP200BOA1	1
-------------	---



- 430 mm
- 950 mm
- 1090 mm

Divinity

Carro multifunción con tres bandejas y dos cubos en polipropileno gris

- ▶ Fabricado en HDPE de gran resistencia
- ▶ 3 prácticas bandejas de servicio ▶ Incluye 2 cubos

Referencia	U. / Caja
AH102POI4	1

Estructura con tres bandejas en polipropileno gris.

AH104POG1	1
-----------	---

Cubo Grande en plástico Negro.

AH105PON4	1 und.
-----------	--------

Cubo Pequeño en plástico Negro.

AH106PON4	1 und.
-----------	--------



- 500 mm
- 895 mm
- 965 mm

Inox

Carro multifunción con tres bandejas en acero inoxidable Aisi 304 Brillo.

- ▶ Bandejas con acanaladura perimetral para evitar el derrame accidental de líquidos.
- ▶ Ideal para su uso en canal Horeca como carro camarera.

Referencia	U. / Caja
AH103AII1	1



Ver
productos



Complementos Hotel

Una parte importante para que los huéspedes disfruten al máximo su estancia en el hotel es el equipamiento hotelero adecuado.

En Jami Brisass® podrás encontrar desde soportes para maletas, perchas, hervidores de agua y bandejas, minibares y complementos para habitaciones y espacios comunes.





675 mm
530 mm
405 mm

620 mm
730 mm
410 mm

Mystic

Soporte para maletas con cuatro cintas de nylon Negro y estructura en acero cromado

- ▶ Estructura de acero de gran resistencia.
- ▶ Tiras de nylon reforzado.
- ▶ Ideal para su uso en hoteles y apartamentos turísticos.

Referencia	U. / Caja
AH610ACC1	2
Con Respaldo AH613ACC1	4



Forte

Poste separador metálico negro con cinta roja extensible

- ▶ Material resistente.
- ▶ Ideal para delimitar zonas en espacios públicos.
- ▶ Cinta roja extensible regulable. Longitud 2m.

Referencia	U. / Caja
AH300MENO	2

910 mm
320 mm



Roque

Poste separador en acero inoxidable brillo con cinta roja extensible.

- ▶ Fabricado en acero inoxidable.
- ▶ Ideal para delimitar zonas en espacios públicos.
- ▶ Cinta roja extensible regulable. Longitud 2m.
- ▶ Acabado brillo muy elegante.

Referencia	U. / Caja
AH300AIB0	2

910 mm
320 mm

Exotic

Soporte para maletas con cuatro cintas de nylon Negro y estructura en madera de roble

- ▶ Estructura en madera de roble.
- ▶ Ideal para su uso en hoteles y apartamentos turísticos.

Referencia	Color	U. / Caja
AH612MAI1	Roble Negro	4
AH612MAC1	Roble Claro NUEVO	4

625 mm
570 mm
445 mm



Onyx

Soporte para maletas con cuatro cintas de cuero sintético Marrón y estructura en hierro negro

- ▶ Estructura resistente fabricada en hierro tratado.
- ▶ Ideal para su uso en hoteles y apartamentos turísticos.

Referencia	U. / Caja
AH615MEN1	9

510 mm
460 mm
410 mm



Inox

Soporte para maletas con cuatro cintas de cuero sintético Marrón y estructura en acero inoxidable brillo

- ▶ Estructura en acero inoxidable.
- ▶ Ideal para su uso en hoteles y apartamentos turísticos.

Referencia	U. / Caja
AH616AIB1	9



510 mm
460 mm
410 mm



Inox

Poste separador en acero inoxidable brillo

- ▶ Fabricado en acero inoxidable.
- ▶ Ideal para delimitar zonas en espacios públicos.
- ▶ Cordones disponibles en varios colores (no incluido)
- ▶ Acabado brillo muy elegante.

Referencia	U. / Caja
AH301AIB1	2

920 mm
320 mm

Cordón para poste cónico separador

● AH302SDR1	1
● AH302SDZ1	1

1,5 m

- ▶ Ideal para delimitar zonas en espacios públicos.
- ▶ Ideal para su uso en lugares públicos.
- ▶ Longitud de 1,5m.



Trona

Silla portabebe plástico gris

- ▶ Silla de bebé de alta resistencia.
- ▶ Peso máximo de seguridad de 35 kg.
- ▶ Incluye bandeja para servicio de alimentación.

Referencia	U. / Caja
AH401ABG0	1

550 mm
740 mm
610 mm





Mayoral

Hervidor de agua de 0,5l. en acero inoxidable Satinado

- ▶ Potencia 1000W.
- ▶ Fácil de abrir y usar.
- ▶ Carcasa resistente a altas temperaturas.

Referencia	Color	U. / Caja
AH272AIS0	Satinado	8



Bellavita

Hervidor de agua de 0,8L en ABS

- ▶ Potencia 1310W.
- ▶ Carcasa resistente a altas temperaturas.
- ▶ Función de paro automático.
- ▶ Indicador de nivel.
- ▶ Aviso luminoso de temperatura.



Referencia	Color	U. / Caja
AH260SDW0	Blanco	12



Velvet

Hervidor de agua de 0,8l. en ABS Negro

- ▶ Potencia 1500W.
- ▶ Fácil de abrir y usar.
- ▶ Carcasa resistente a altas temperaturas.
- ▶ Incluye indicador de nivel.



Referencia	Color	U. / Caja
AH269ABN0	Negro	8



Novelda

Bandeja de servicio para hervidor en plástico color Negro

- ▶ Material plástico de alta resistencia.
- ▶ Apto para contener cualquier modelo de hervidor Jami.
- ▶ Dispone de varios compartimentos.



Referencia	Color	U. / Caja
AH271ABN1	Negro	10



Celestia

Bandeja para bolsitas en melamina

- ▶ Material resistente a las quemaduras.
- ▶ Base de goma para una mayor adherencia.
- ▶ Con compartimento para bolsitas grandes.

Grande

Referencia	Color	U. / Caja
AH264SDW0	Blanco	48
AH264SDN0	Negro	48

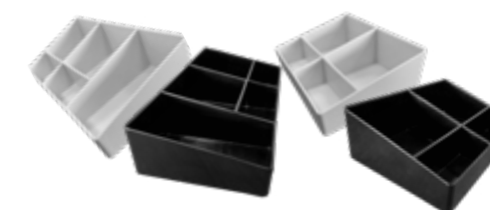

Pequeña

Referencia	Color	U. / Caja
AH263SDW0	Blanco	48
AH263SDN0	Negro	48



Génesis

Bandeja de servicio para hervidor en melamina

- ▶ Material resistente a las quemaduras.
- ▶ Base de goma para una mayor adherencia.

Servicio

Referencia	Color	U. / Caja
AH262SDW0	Blanco	36
AH262SDN0	Negro	36



Principal

Referencia	Color	U. / Caja
AH261SDW0	Blanco	12
AH261SDN0	Negro	12





Tabur

Perchero de suelo con peana y ocho colgadores de acero Negro y bolas de plástico cromado

- ▶ Fabricado en acero.
- ▶ Apropiado para oficinas y colectividades.
- ▶ 8 colgadores.

Referencia	U. / Caja
AH700ACN1	2

1.640 mm

400 mm



Emir

Perchero de pared con cuatro colgadores de acero y chapa electrocincada color Negro

- ▶ Apropiado para oficinas y colectividades.
- ▶ Posibilidad de configurar diferentes colores y nº de colgadores (por encargo)

Referencia	U. / Caja
AH701ACN1	20

560 mm

110 mm

45 mm



Color personalizable



Xantia

Botiquín sanitario completo con llave de seguridad en polipropileno Blanco.

- ▶ Botiquín completo con todos sus accesorios.
- ▶ Listo para su uso inmediato.
- ▶ Cruz verde homologada.

Referencia	Color	U. / Caja
AH502POW1	Blanco	4

202 mm

195 mm

144 mm

Paragüeros

Aida

Paragüero en acero blanco y ABS negro 15L

Referencia	Color	U. / Caja
AH900ACW1	Blanco	1

Dalia

Paragüero en acero inoxidable satinado y ABS negro 15L

Referencia	Color	U. / Caja
AH901AIS1	Satinado	1



500 mm

210 mm

- ▶ Resistentes a la oxidación.
- ▶ Apropiadados para oficinas y colectividades.
- ▶ Base de goma en la base.



Ayaz

Minibar termoeléctrico silencioso con potencia de 220V.

- ▶ Dispone de termostato para regulación de temperatura.
- ▶ Refrigeración mediante sistema Peltier de bajo mantenimiento.
- ▶ Luz led interior.
- ▶ Sistema de descongelación automática.

Referencia	Color	U. / Caja
AH200SDI1	Negro	1

380 mm

470 mm

440 mm



Fortalaz

NUEVO

Caja fuerte de alta seguridad

- ▶ Elegante diseño
- ▶ Cerradura electronica automática mediante botonadura con display led
- ▶ Luz interior
- ▶ Apertura por clave privada, clave maestra o llave

Referencia	Color	U. / Caja
AH267SDI0	Negro	1

420mm

240mm

370mm

Ver productos



Duchas Lavaojos

Las duchas lavaojos de emergencia se consideran dispositivos de seguridad en el trabajo. Actuando de forma rápida y eficaz cuando un trabajador, descontamina el ojo, ya sea por polvo, gases u otras sustancias químicas.



DL104SDI1
 254 mm
 1067 mm
 380 mm



DL103SDI1
 254 mm
 240 mm
 380 mm



DL100SDI1
 335 mm
 2286 mm
 635 mm



DL101SDI1
 350 mm
 2350 mm
 600 mm

Velvet

Duchas lavaojos de pared o pie en acero galvanizado y PEHD.

- Poza resistente a la corrosión.
- Tuberías de acero galvanizado.
- Presión óptima para el lavado de ojos.
- Compensador automático de flujo que asegura un caudal constante.
- Cumple la norma con la norma EN-15154-2:2007.

Referencia	Modelo	Color	U. / Caja
DL104SDI1	Ducha lavaojos de pie Velvet	Acero galvanizado y PEHD.	1
DL103SDI1	Ducha lavaojos de pared Velvet	Acero galvanizado y PEHD.	1
DL100SDI1	Ducha lavaojos palanca de pie Velvet	Acero galvanizado y PEHD.	1
DL101SDI1	Ducha lavaojos palanca/pedal de pie Velvet	Acero galvanizado y PEHD.	1



230 mm
 290 mm
 80 mm



80 mm
 220 mm
 80 mm

- Cada botella da para 3 minutos de irrigación.
- Solución salina en agua purificada.
- Líquido adecuado para enjuagar los ojos ante lesiones con cuerpos extraños.
- Cumple norma CE.

Referencia	Modelo	U. / Caja
DL106SDI1	Estación lavaojos con espejo de dos botellas de 500ml con solución salina.	1
DL105SDI1	Botella de solución salina de 500ml para ducha lavaojos.	1

Condiciones generales

Las condiciones generales de venta que se exponen a continuación se entienden aceptadas por parte de Productos Jami Brisass, s.l. y sus clientes en relación a cualquier operación comercial y en especial a la petición de un pedido.

PEDIDOS

Todos los pedidos deben cursarse a través de un documento escrito preferiblemente con número de pedido expreso.

La entrega de la mercancía se efectuará en las instalaciones que el cliente disponga a tal efecto y que haya comunicado previamente a Productos Jami Brisass, s.l.

Si el cliente lo desea la entrega puede hacerse en otra dirección, estando obligado en este caso a expresarlo por escrito en cada pedido.

Productos Jami Brisass, s.l. no será responsable por los retrasos en las entregas debidos a causas de fuerza mayor, medidas gubernamentales, huelgas, etc. u otras causas que no estén bajo el control de Productos Jami Brisass, s.l.

FORMAS DE PAGO

Los pedidos cuyo importe sean inferiores a 200€ serán abonados mediante transferencia bancaria antes del envío de la mercancía.

Para clientes SIN clasificación de riesgo la forma de pago será Contado, efectivo o transferencia bancaria previa al envío.

Para clientes CON clasificación de riesgo la forma de pago será Cheque, Pagaré, o recibo domiciliado a la vista a la entrega de la mercancía.

Una forma distinta de pago a la de contado será estudiada por nuestro departamento financiero.

PORTES Y SEGUROS DE LA MERCANCÍA

Para entregas en la Península los portes serán pagados por compras superiores a 350 € + I.V.A., excepto en mobiliario urbano, taquillas y contenedores, cuyo porte correrá a cargo del cliente.

La entrega se realizará en planta baja, no estando obligados a descargas a terceros o colocación de la mercancía en sus ubicaciones correspondientes.

Requisitos para entrega de mercancías: Dirección, teléfono, persona de contacto, Vía pública con acceso de vehículos, muelle de carga si se trata de mercancía voluminosa, horario de comercio.

En los envíos a portes pagados, la mercancía irá asegurada por Productos Jami Brisass, s.l. En el caso de que el cliente detecte siniestro en la entrega de dicha mercancía o la falta de algún bulto, es imprescindible que tal hecho se haga constar en el albarán del transportista, comunicando la incidencia por e-mail a la dirección (jamibrisass@jamibrisass.com) en un plazo máximo de 24 horas después de que la mercancía haya sido recepcionada. En caso contrario Jami Brisass, s.l. podría no responsabilizarse de la mercancía dañada o de los bultos no recibidos por el cliente. En cualquier caso siempre debemos poner a la recepción de la mercancía "Pendiente de revisar".

GARANTÍA

Productos Jami Brisass, s.l. suministra todos los productos con Garantía. Las condiciones generales de garantía están determinadas por cada tipo de producto y por su propio fabricante.

DEVOLUCIONES

El cliente puede solicitar a Productos Jami Brisass, s.l. la devolución del material, siempre que no hayan transcurrido más de 15 días naturales desde la fecha de facturación, para lo cual deberá dirigirse a nuestro departamento de Atención al Cliente.

La recepción de la mercancía devuelta no significa la aceptación definitiva de la devolución del importe del material. Esta aceptación sólo será definitiva tras la comprobación del material en nuestro Departamento Técnico. No se admitirán devoluciones de productos personalizados o fuera de catálogo.

El material devuelto debe ir en su embalaje original y en perfecto estado. En las devoluciones no imputables a errores de Productos Jami Brisass, s.l. los portes los paga el cliente y se producirá un cargo del 15% por depreciación en concepto de gastos por manipulación y revisión en caso de necesitarlos.

El envío del material a devolver a las instalaciones de Productos Jami Brisass, s.l. se realizará a portes pagados, excepto en caso de que la devolución sea motivada por error de Productos Jami Brisass, s.l. en la que se hará cargo de dicho transporte.

FUERO

Con renuncia al fuero que pudiera corresponderle al cliente, todas las controversias que pudieran eventualmente suscitarse, serán sometidas a los juzgados y tribunales de Málaga.

NOTA FINAL

Las medidas, fotografías y productos que aparecen en este catálogo son a título informativo. Productos Jami Brisass, s.l. se reserva el derecho de modificarlos o rectificarlos sin previo aviso, con el compromiso de informar a los clientes a la mayor brevedad posible. En caso de error sobre medidas o precios en el catálogo se considerará error de imprenta y se dará por correcta la rectificación aportada por Productos Jami Brisass, s.l.





Jami
HIGIENE, DISEÑO Y CALIDAD

EXPOSITOR ROYAL

Selección de productos de equipamiento JAMI® de alta rotación y con la mejor relación calidad/precio, con el objetivo de que tu negocio disponga del mejor escaparate para atraer a tus clientes.

Consulta con nuestros agentes comerciales para contar con esta herramienta y optimiza ya la venta de tus productos Jami Brisass.

Desde 1973
Equipamiento Profesional
para la Higiene y Colectividades



Desde 1973

Equipamiento Profesional para la Higiene y Colectividades

Oficinas Centrales

C/César Vallejo, 17 Pol. Ind. Guadalhorce
29004 - Málaga
Telf. 952 32 66 16
jamibrisass@jamibrisass.com
www.jamibrisass.com

Fábrica y Centro Logístico

C/ Asturias, 1-2-3 Parcelas 90-91-92 Manzana E
Parque Empresarial de Antequera
29200 - Antequera (Málaga)
antequera@jamibrisass.com

Delegación Sevilla

C/ Gramaje, 8A - Nave 11 Pol. Ind. La Negrilla
41016 - Sevilla
Telf. 955 128 244
sevilla@jamibrisass.com

Catálogo General 2025/26

Jami
HIGIENE, DISEÑO Y CALIDAD

